

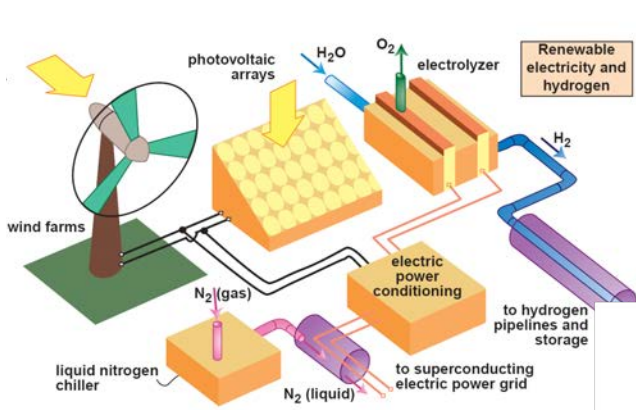
Lecture # 22

Wind Energy

Ahmed Ghoniem
April 27, 2020

- A quick recap, what we covered and what is yet to come
- Wind energy resources and potential
- Wind machines and wind turbine physics

The lecture today is ~ 90 min



Hoffert et al., Science, 298 (2002)

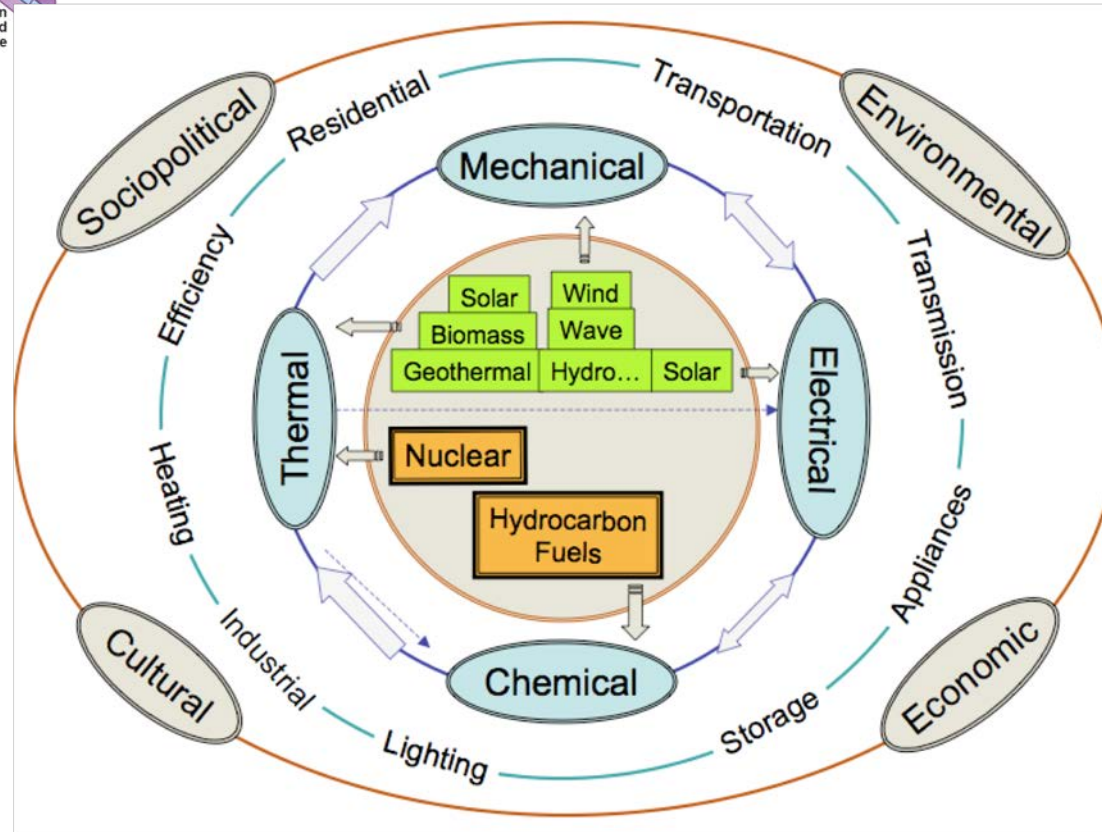
© AAAS. All rights reserved. This content is excluded from our Creative Commons license. For more information, see <https://ocw.mit.edu/fairuse>.



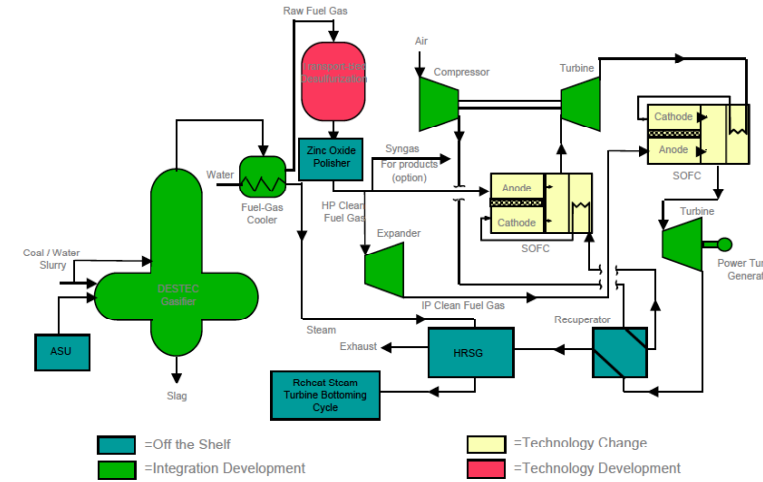
Thermodynamics of the Corn-Ethanol Biofuel Cycle

© Informa UK Limited. All rights reserved. This content is excluded from our Creative Commons license. For more information, see <https://ocw.mit.edu/fairuse>.

Tad W. Patzek (2004) "Thermodynamics of the Corn-Ethanol Biofuel Cycle", *Critical Reviews in Plant Sciences*, 23:6, 519-567, DOI: [10.1080/07352680490886905](https://doi.org/10.1080/07352680490886905).



© by Ahmed F. Ghoniem



Fuel cell handbook. Office of fossil energy.

Image courtesy of DOE.

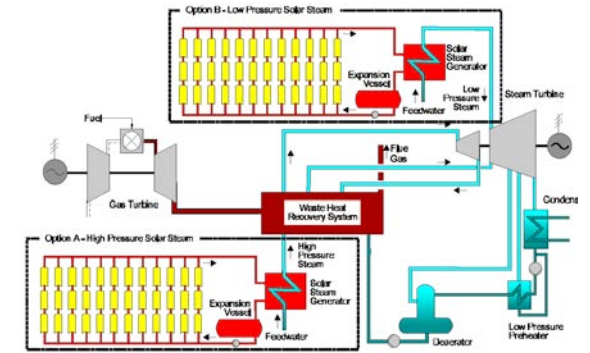


Figure 2. Integrated Solar Combined Cycle System [1].

Mancini TR. An overview of concentrating solar power.

Image courtesy of DOE.

Electrification Worldwide

- Less developed countries have 80% of world's population, consume ~ 30% of total energy
- ~2B people without consistent access to electricity
- The system is moving away from fuels and towards electricity, for many reasons
- Opportunities and challenges

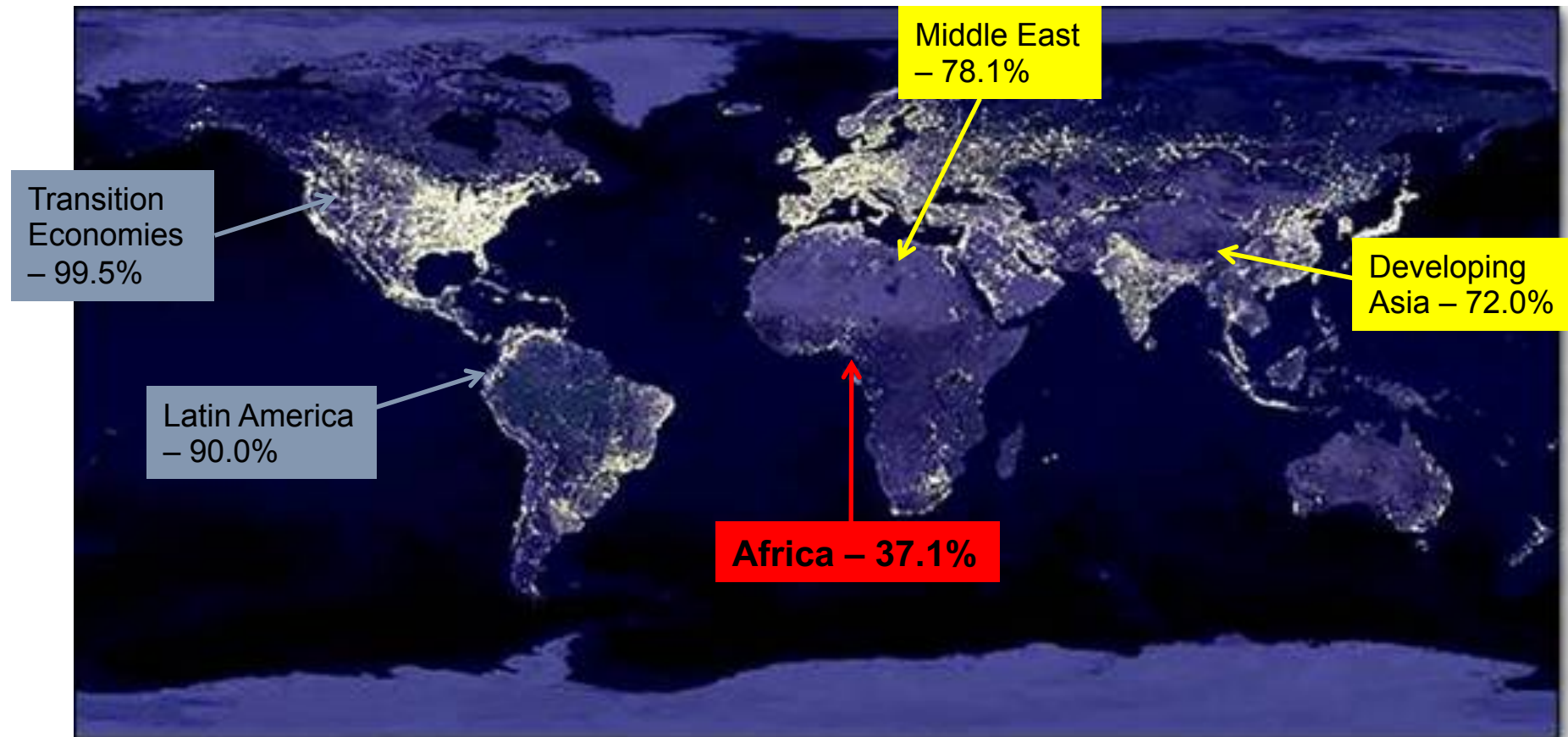
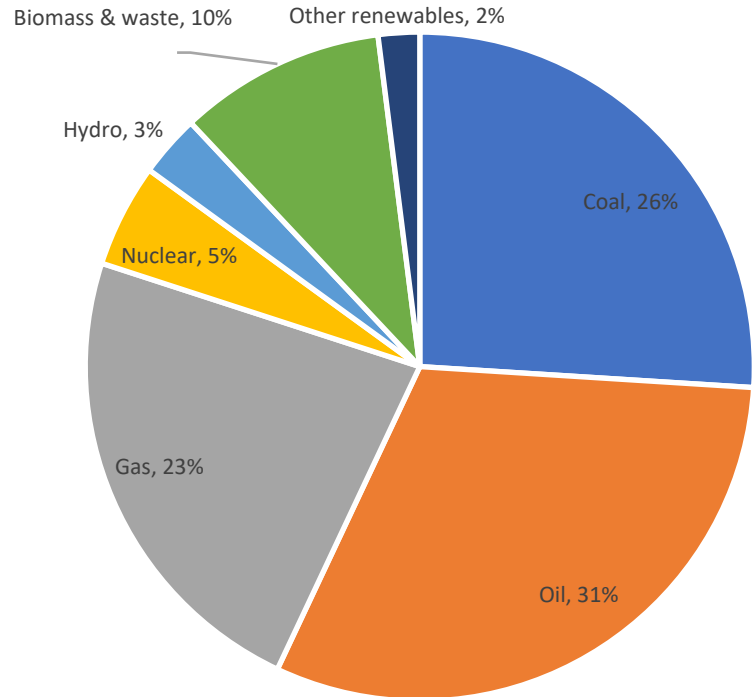


Image courtesy of NASA.

Needs: Energy Consumption

~ 600 EJ (~ 440 EJ in early 2000's) produced by close to 18 TW Power (6.1 TW for electricity generation)



© IEA. All rights reserved. This content is excluded from our Creative Commons license. For more information, see <https://ocw.mit.edu/fairuse>.

World primary energy consumption in 2014, 13,558 Mtoe (was 11,059 Mtoe in 2006). Except for hydropower, primary energy measures the thermal energy equivalent in the fuel that was used to produce a useful form of energy, e.g., thermal energy (heat), mechanical energy, electrical energy, etc. When energy is obtained directly in the form of electricity, efficiency is used to convert it to equivalent thermal energy. 1 toe ~ 42 GJ. IEA World Energy Outlook 2015, p57.

Sankey diagram
US resources, consumption and patterns
~100 EJ/y 2018, <17% of the world total (25% in 2004)

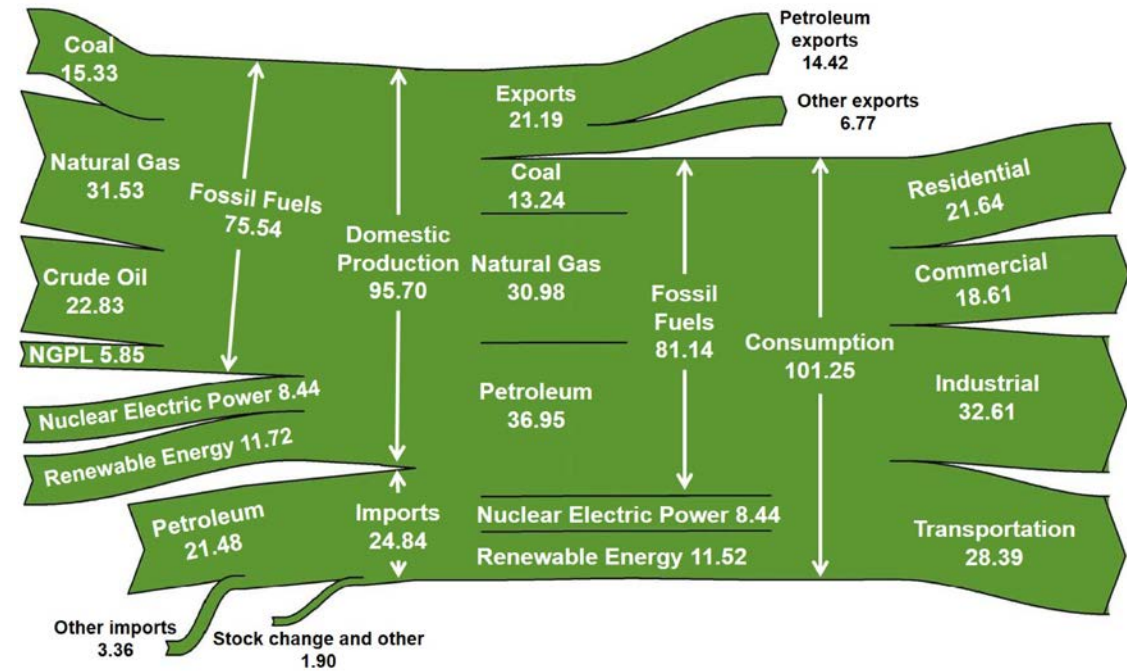
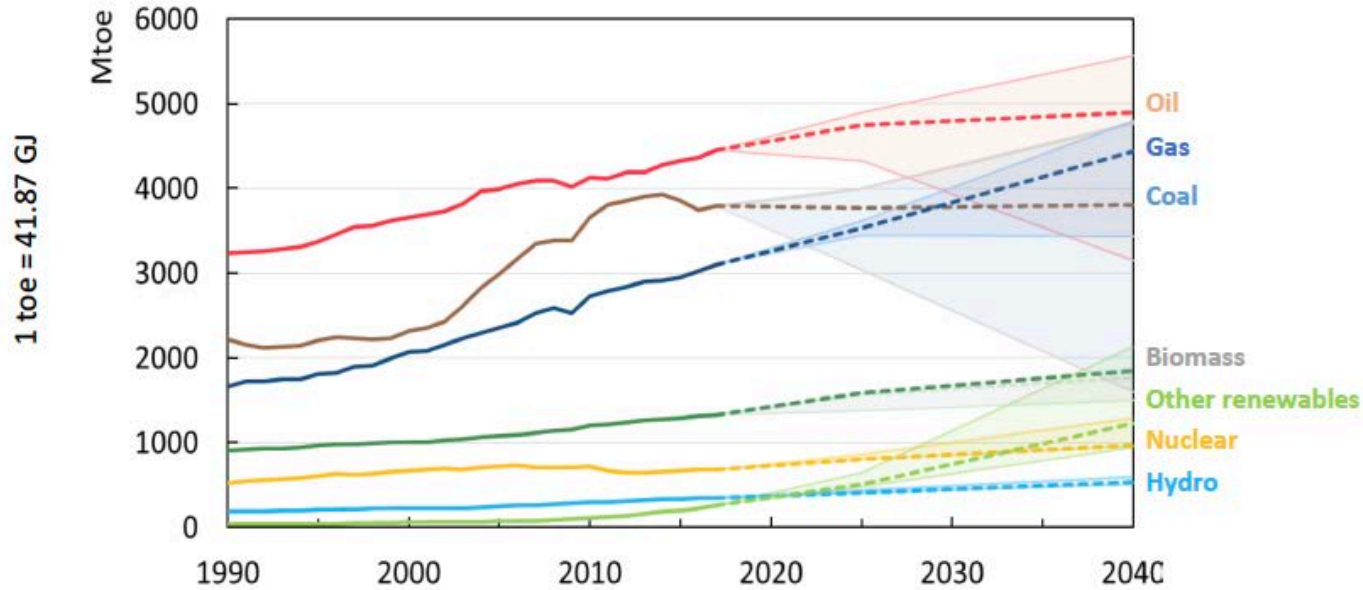


Image courtesy of U.S. Energy Information Administration.

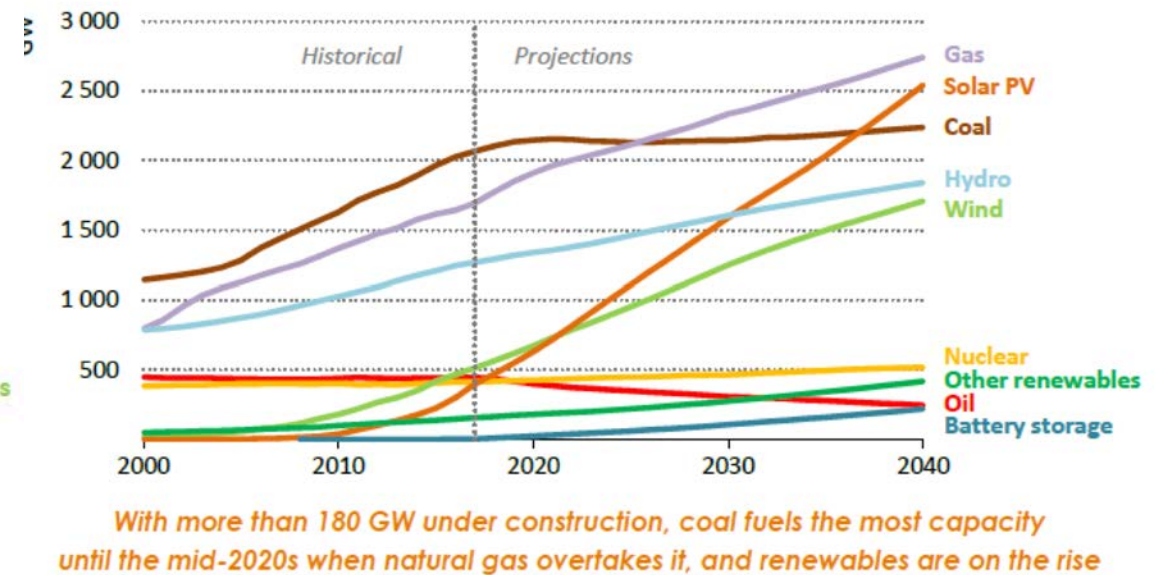
http://www.eia.gov/totalenergy/data/monthly/pdf/flow/total_energy.pdf

World primary energy supply by fuel/source*

The dotted line is the prediction based on new policies to be implemented. The shaded areas show the possible scenarios between current policies and sustainable development. Source: IEA world energy outlook 2018, P38



Installed power (electricity) generation capacity worldwide by source and prediction in the new policies scenario

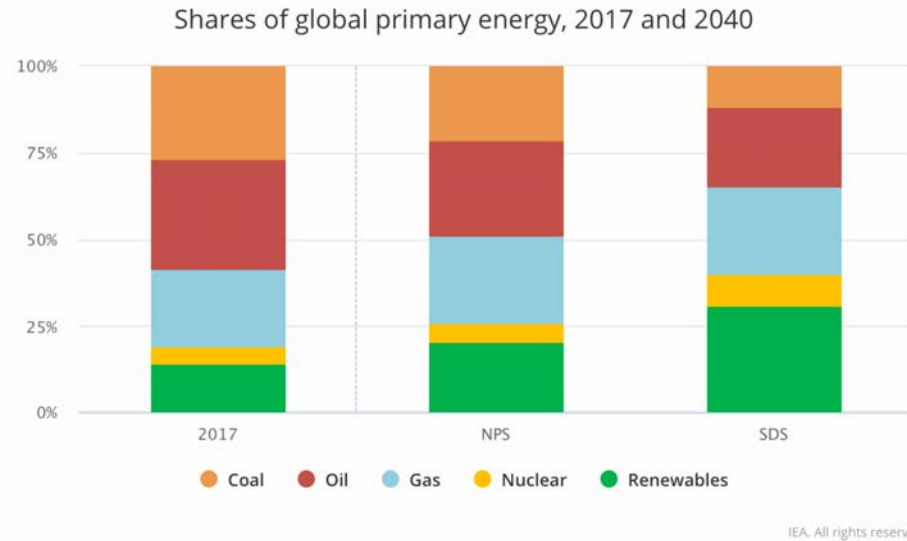


© IEA. All rights reserved. This content is excluded from our Creative Commons license. For more information, see <https://ocw.mit.edu/fairuse>.

Source: IEA world energy outlook 2018, P344

Shares of global primary energy, 2017 and 2040

Source: <https://www.iea.org/weo2018/fuels/>



© IEA. All rights reserved. This content is excluded from our Creative Commons license. For more information, see <https://ocw.mit.edu/fairuse>.

New Policies Scenario (NPS): Global oil demand growth slows but does not peak before 2040.

Sustainable Development Scenario (SDS): Determined policy interventions to address climate change lead to a peak in global oil demand around 2020 at 97 mb/d.

Global Greenhouse Gas Emissions by Economic Sector (2015)

https://www.epa.gov/sites/production/files/2016-05/global_emissions_sector_2015.png

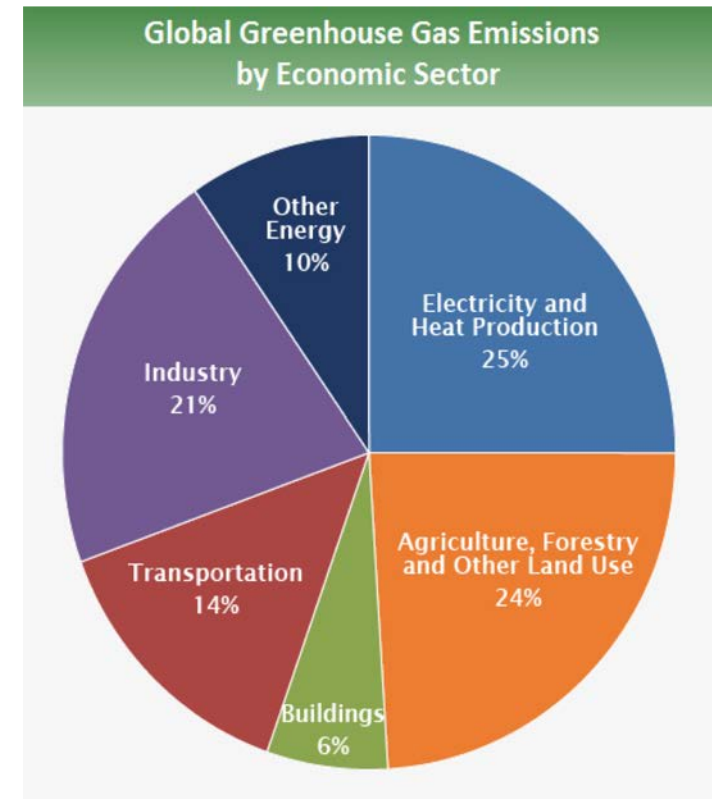
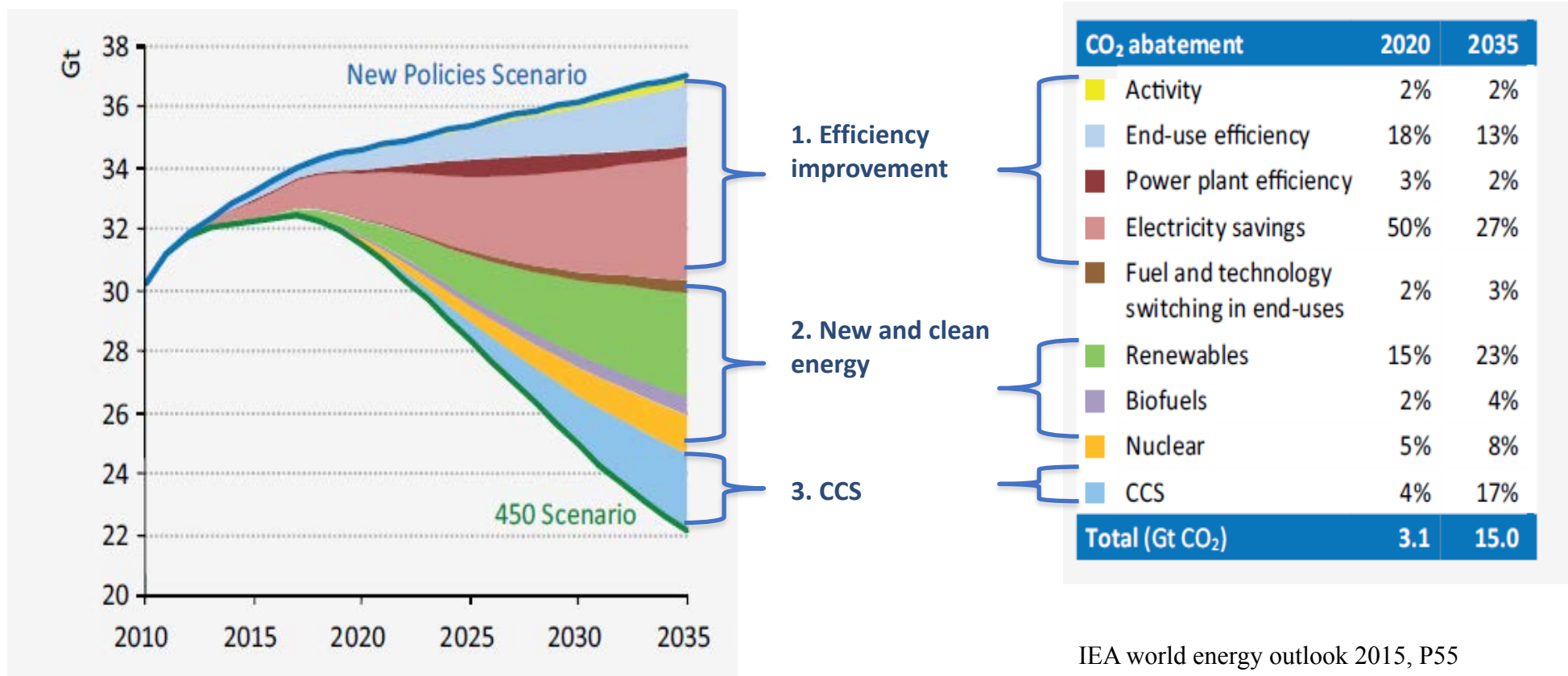


Image courtesy of EPA.

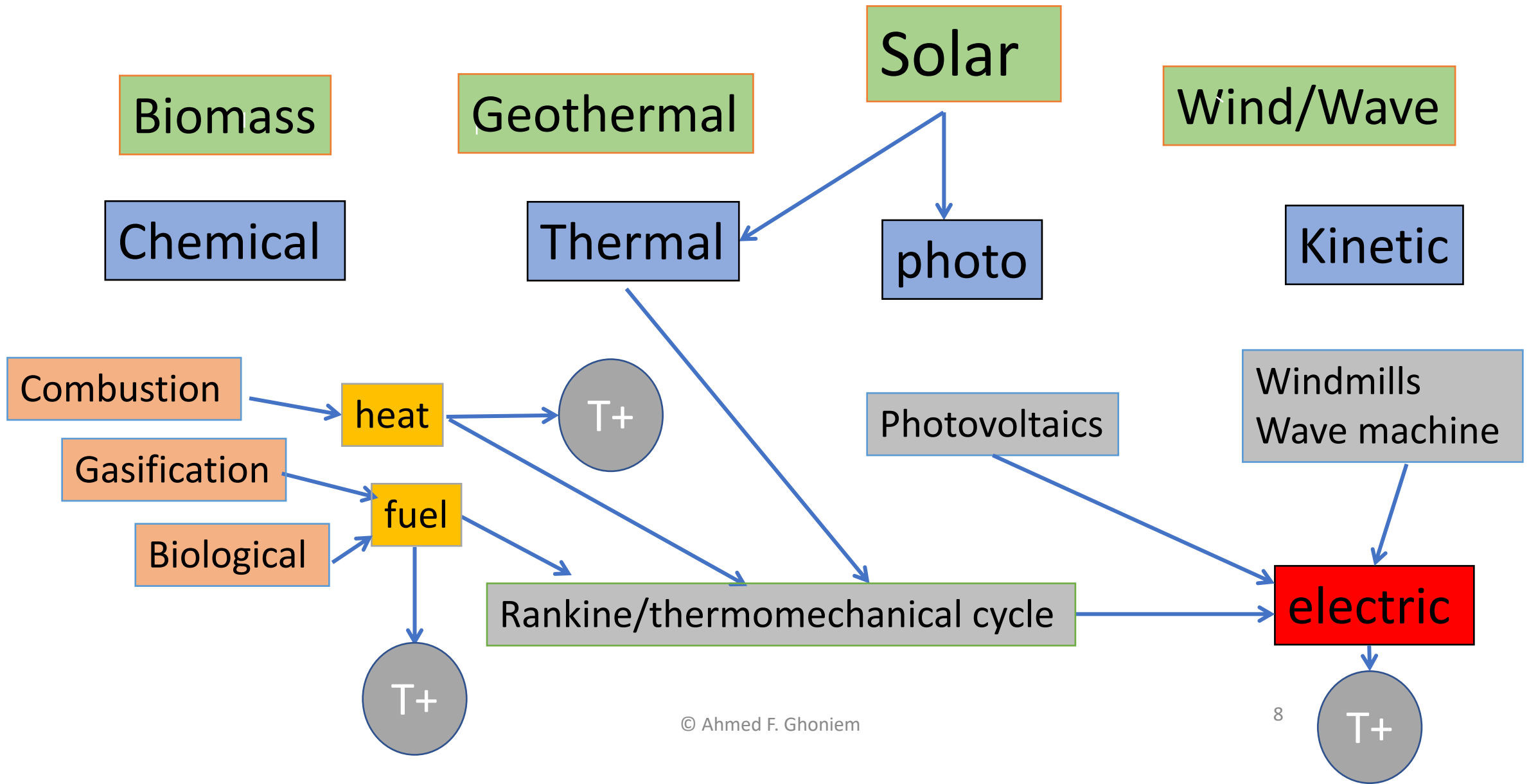
Meeting CO₂ targets using a portfolio of technologies

- New policies scenario: implementing measures affecting energy markets that had been adopted as of mid-2015 (as well as the energy-related components of climate pledges in the run-up to COP21)
- 450 scenario: depicts a pathway to the 2° C climate goal that can be achieved by fostering technologies that are close to becoming available at commercial scale.



IEA world energy outlook 2015, P55

Renewable Sources and Their Utilization



Significant Potential for Wind

TABLE 4.1 Onshore and Offshore Wind Potential for the 10 Countries Identified as the Largest National Emitters of CO₂ [4]

No.	Country	CO ₂ Emission/ (10 ⁶ Metric Tonnes)	Electricity Consumption/ (TW h)	Potential Wind Energy/(TW h)		
				Onshore	Offshore	Total
1	China	8547.7	4207.7	39 000	4600	44 000
2	United States	5270.4	3882.6	74 000	14 000	89 000
3	India	1830.9	757.9	2900	1100	4000
4	Russia	1781.7	869.3	120 000	23 000	140 000
5	Japan	1259.1	983.1	570	2700	3200
6	Germany	788.3	537.9	3200	940	4100
7	South Korea	657.1	472.2	130	990	1100
8	Iran	603.6	185.8	5600	–	5600
9	Saudi Arabia	582.7	211.6	3000	–	3000
10	Canada	499.1	551.6	78 000	21 000	99 000

Note: CO₂ emission for 2012 and electricity consumption for 2011.
 Source: Data from Boden TA, Andres RJ, Marland G. Preliminary 2011 and 2012 global & national estimates. In: Fossil-fuel CO₂ emissions. Oak Ridge, TN: Carbon Dioxide Information Analysis Center; 2013. p. 4 [19] and US EIA. International energy outlook. Washington, DC: U.S. Energy Information Administration; 2013. p. 312 [20].

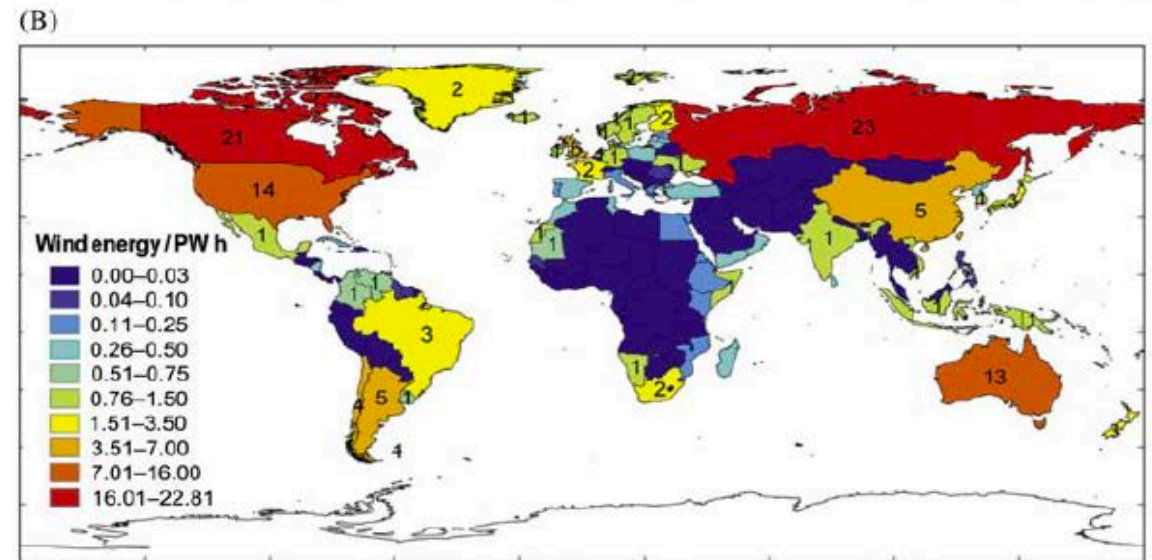
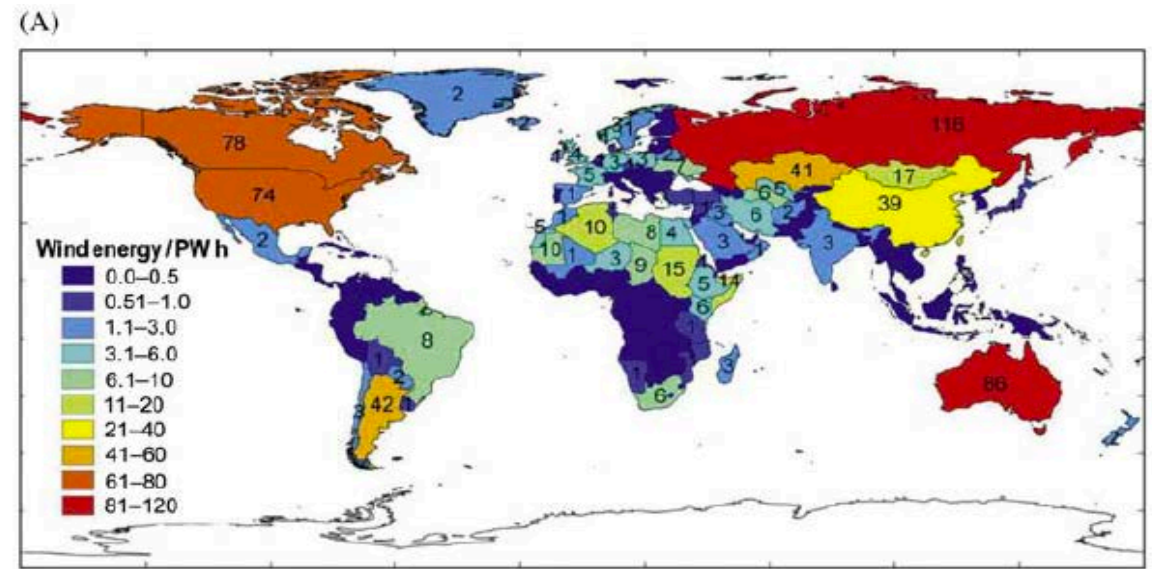
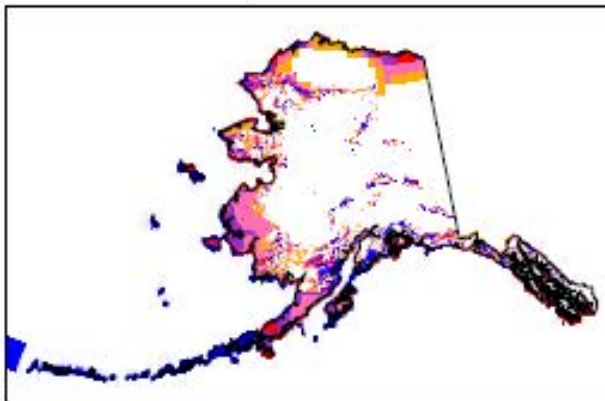
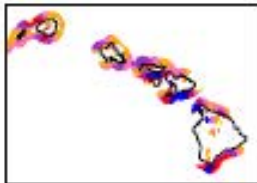
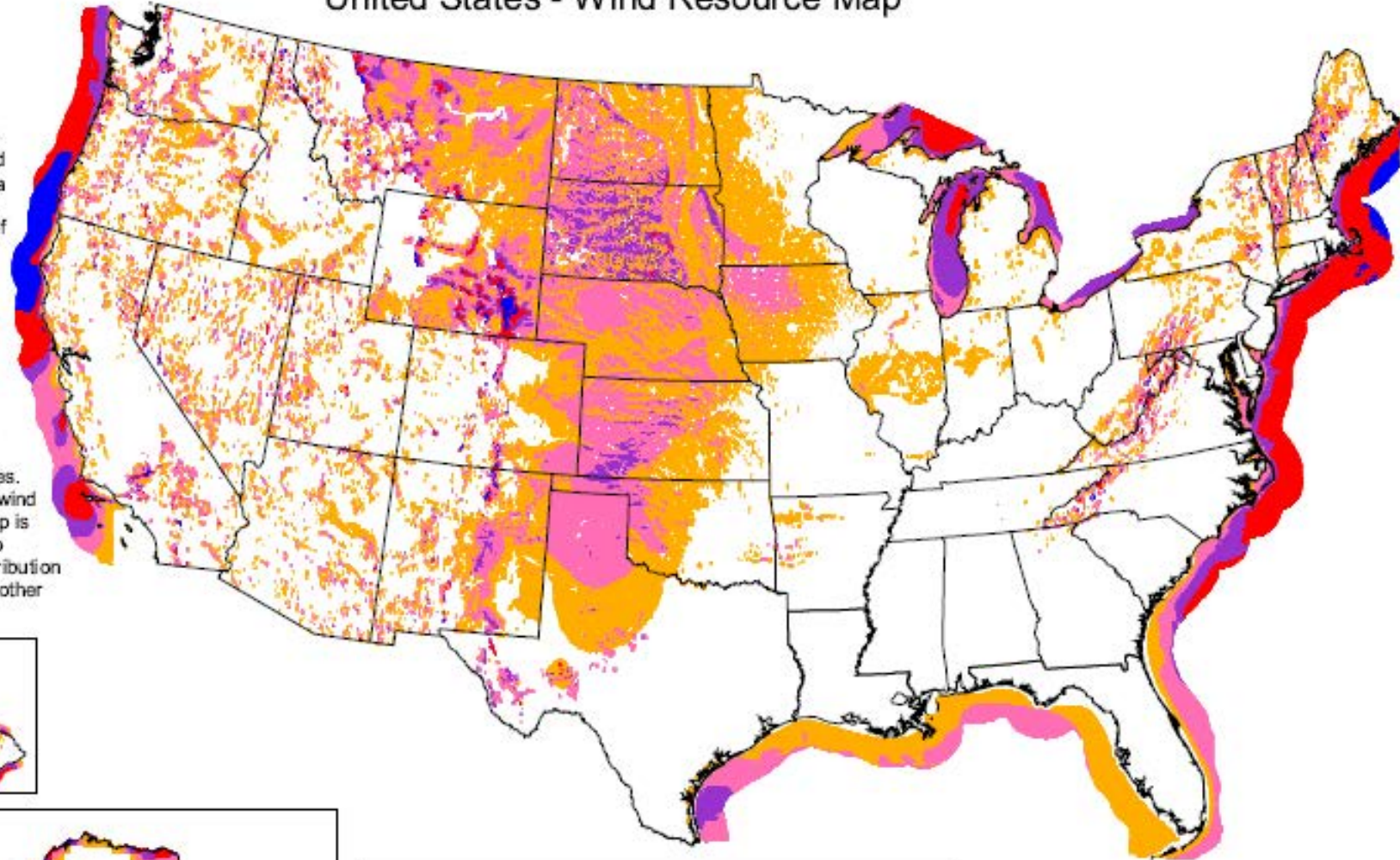


FIGURE 4.4 Annual wind energy potential country by country, restricted to installations with capacity factors greater than 20% with siting limited as discussed in the text: (A) onshore and (B) offshore [4].

United States - Wind Resource Map

This map shows the annual average wind power estimates at a height of 50 meters. It is a combination of high resolution and low resolution datasets produced by NREL and other organizations. The data was screened to eliminate areas unlikely to be developed onshore due to land use or environmental issues. In many states, the wind resource on this map is visually enhanced to better show the distribution on ridge crests and other features.

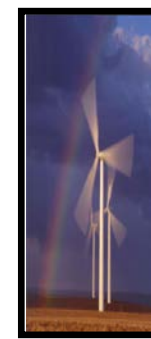


Wind power class and potential	Power density at 50 m, W/m ²	Wind speed at 50 m, m/s
3 Fair	300-400	6.4-7.0
4 Good	400-500	7.0-7.5
5 Excellent	500-600	7.5-8.0
6 Outstanding	600-800	8.0-8.8
7 Superb	800-1600	8.8-11.1

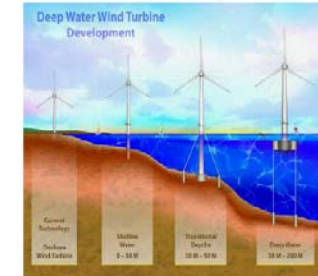


Image courtesy of NREL, DOE.

Global Wind Statistics, 2017



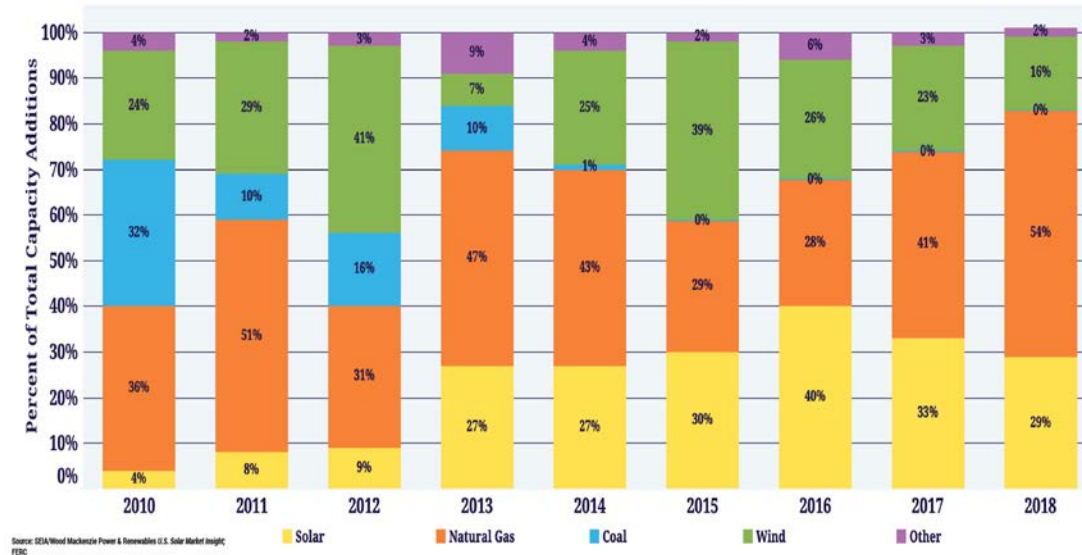
Explore technology pathways for installing and operating large wind power facilities in water depths greater than 30 meters.



© Source unknown. All rights reserved. This content is excluded from our Creative Commons license. For more information, see <https://ocw.mit.edu/fairuse>.

In the US

Annual Additions of New Electric Capacity



Source: EIA/Wood Mackenzie Power & Renewables U.S. Solar Market Insight; FERC

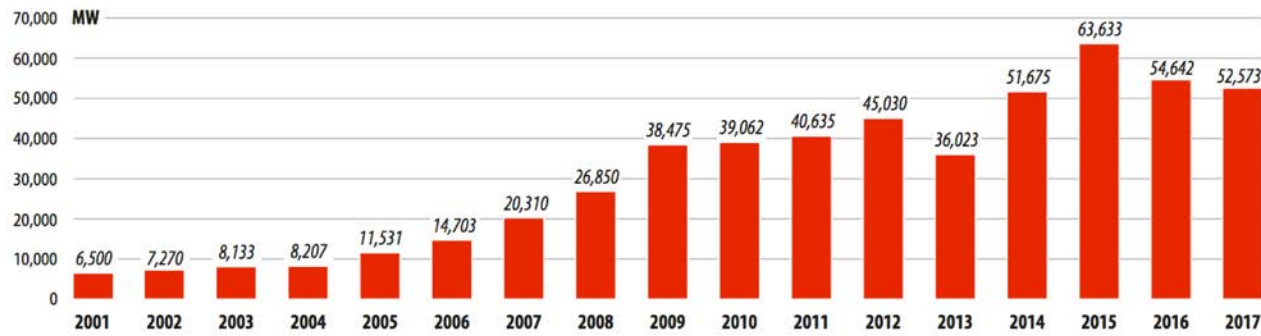


©2019

www.seia.org/solar-industry-research-data

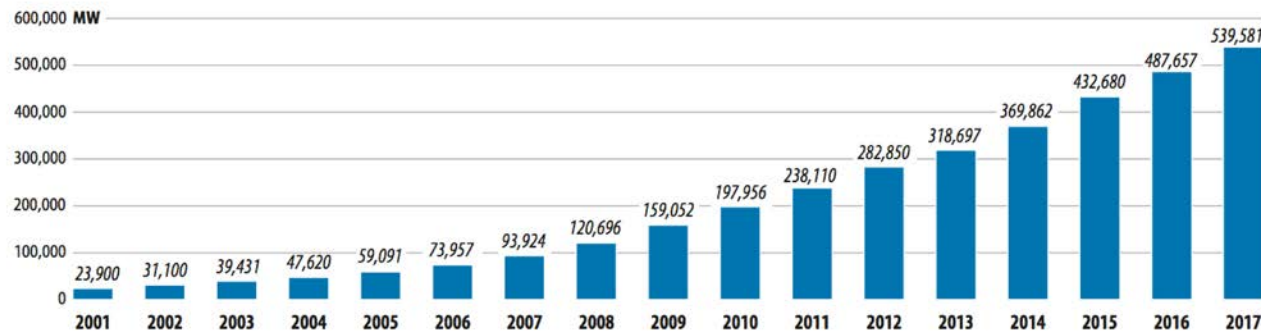
© Solar Energy Industries Association. All rights reserved. This content is excluded from our Creative Commons license. For more information, see <https://ocw.mit.edu/fairuse>.

GLOBAL ANNUAL INSTALLED WIND CAPACITY 2001-2017



Source: GWEC

GLOBAL CUMULATIVE INSTALLED WIND CAPACITY 2001-2017



Source: GWEC

© Global Wind Energy Council (GWEC). All rights reserved. This content is excluded from our Creative Commons license. For more information, see <https://ocw.mit.edu/fairuse>.

Extracting Wind Energy

$$P = \frac{1}{2} \dot{m} V_{wind}^2 = \frac{1}{2} \rho_{air} V_{wind}^3 A$$

Take: $\rho_{air} \sim 1.3 \text{ kg/m}^3$, $V \sim 10 \text{ m/s}$, $R_{turbine} \sim 10 \text{ m}$

$P \sim 180 \text{ kW}$ (assuming 100% conversion efficiency)



Old fashion wind mill

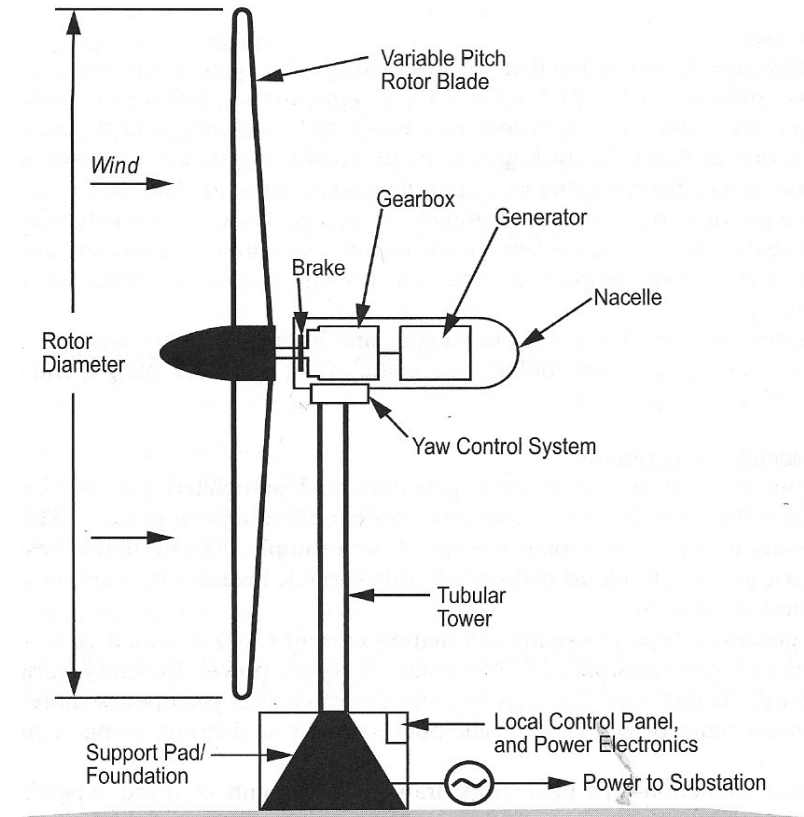


Unusual vertical axis wind machine

MacKay, Sustainable Energy-without the hot air, Cambridge, 2009.



Modern horizontal axis wind turbine (3 blades)



1/18/2019. Rotterdam. GE announced plans this week to erect a prototype of the world's largest wind turbine, the Haliade-X, on the city's outskirts.



12 MW capacity

220-meter rotor

107-meter long blades

260 meters high

67 GWh gross AEP

63% capacity factor

38,000 m² swept area

Wind Class IEC: IB

Generates **double the energy** as previous GE Haliade model

Generates almost **45% more energy** than most powerful wind turbine available on the market today

Will generate enough clean power for up to **16,000** European households per turbine, and up to **1 million** European households in a 750 MW configuration windfarm



HALIADÉ-X 12 MW

GE Renewable Energy is developing **Haliade-X 12 MW**, the biggest offshore wind turbine in the world, with **220-meter rotor**, **107-meter blade**, leading capacity factor (**63%**), and **digital capabilities**, that will help our customers find success in an increasingly competitive environment.

1063 ft
324 m

853 ft
260 m

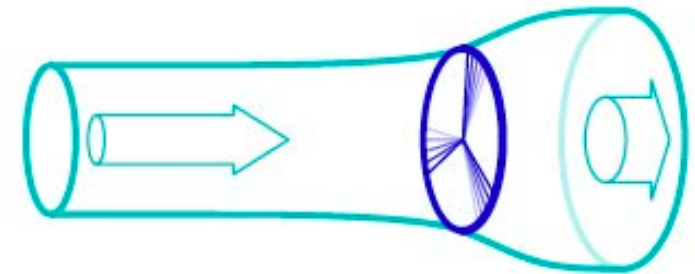
1046 ft
319 m

Eiffel Tower Haliade-X 12 MW Chrysler Building

What determines the efficiency/coefficient of performance of a wind machine?

Several models can be used to examine how the machine captures energy

- The actuator disk theory is the simplest approach to evaluating the ideal power extracted by a wind machine.
- Assumes ideal conditions with no losses.
- Thrust generated by the turbine is due to pressure change across the disk. The disc obstructs the flow, slowing it down as it approaches the machine
- Assumes that wind *can pass through* the swept area.
- Flow in the wake (or inside the disk) is not rotating!
- Aerodynamics is left out!



mass conservation: $A_\infty U_\infty = A_d U_d = A_w U_w = \frac{\dot{m}}{\rho}$

Bernoulli: $p_\infty + \frac{1}{2} \rho U_\infty^2 = p^+ + \frac{1}{2} \rho U_d^2$

$$p^- + \frac{1}{2} \rho U_d^2 = p_\infty + \frac{1}{2} \rho U_w^2$$

Momentum (across disk): $T = (p^+ - p^-) A_d$

Momentum (entire CV): $T = \dot{m}(U_\infty - U_w)$

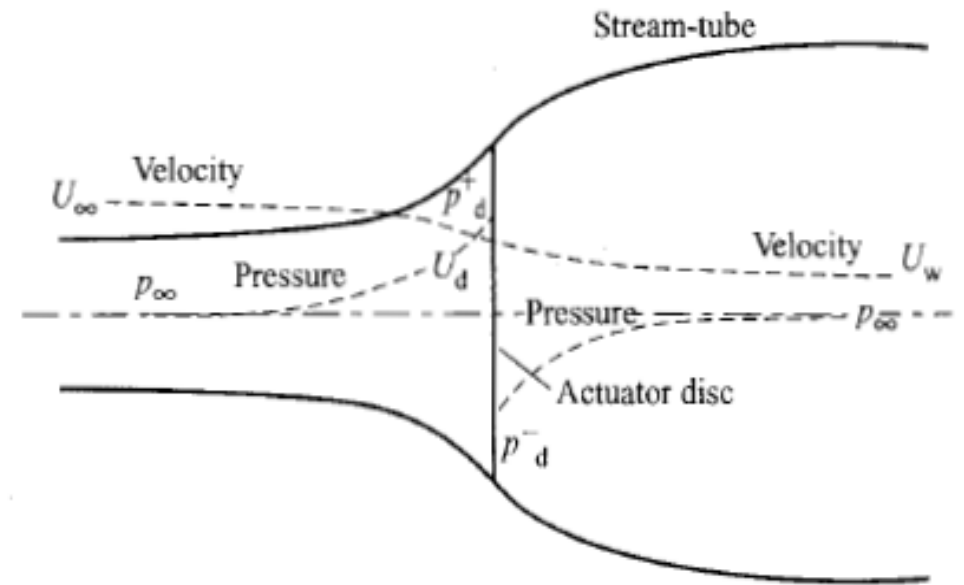
Solve: $U_d = \frac{1}{2}(U_\infty + U_w),$

$$T = 2\rho A(U_\infty - U_d)U_d \quad \text{and} \quad \wp = T U_d = 2\rho A(U_\infty - U_d)U_d^2$$

the power coefficient is $C_p = \frac{\wp}{\frac{1}{2} \rho U_\infty^3 A_d} = 4\alpha(1-\alpha)^2, \quad \alpha = \frac{U_\infty - U_d}{U_\infty}$

for maximum power: $\alpha=1/3,$ and $U_d = \frac{2}{3}U_\infty.$

Maximum Power Coefficient, Betz limit (efficiency): $C_p = 0.593$



Modern Wind turbines utilize lifting surfaces (wings) to extract energy:

- Place your hand perpendicular to the wind: you experience "bluffbody or wake drag"
- Place your hand at a small angle with the wind you experience lift force like a wing.
- This is a more efficient way to produce force without blocking the wind.
- Modern wind "turbines" (not old "windmills") are made of blades that look like wings.



Vesta 7MW turbines, rotor D = 164 m, in an off-shore farm.

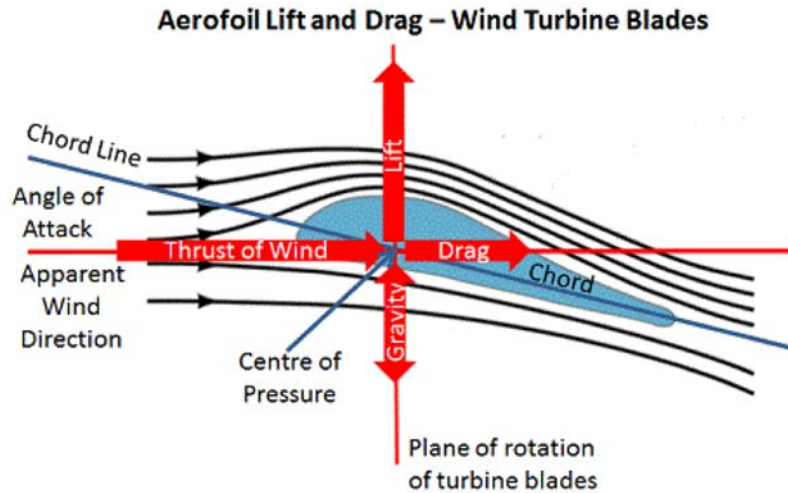
https://www.mpoweruk.com/wind_power.htm



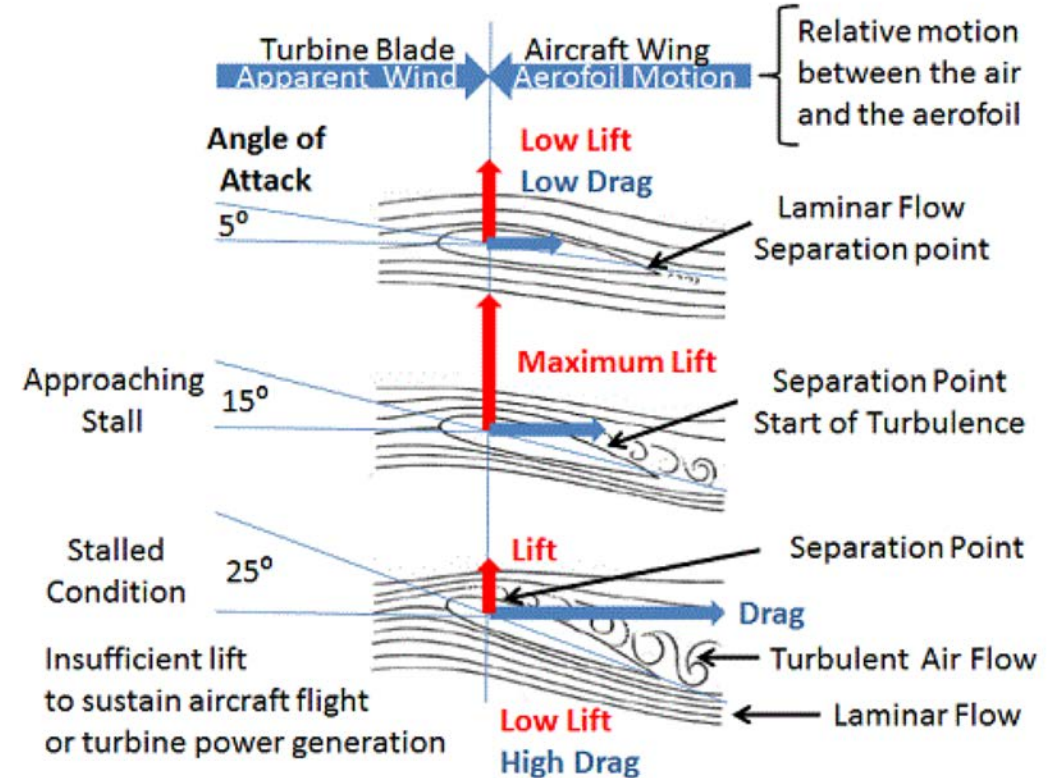
Wind turbines utilize lifting surfaces (wings) to extract energy:

Lift: force perpendicular to the relative velocity

Drag: force in the direction of the relative velocity



Lift, Drag and Angle of Attack



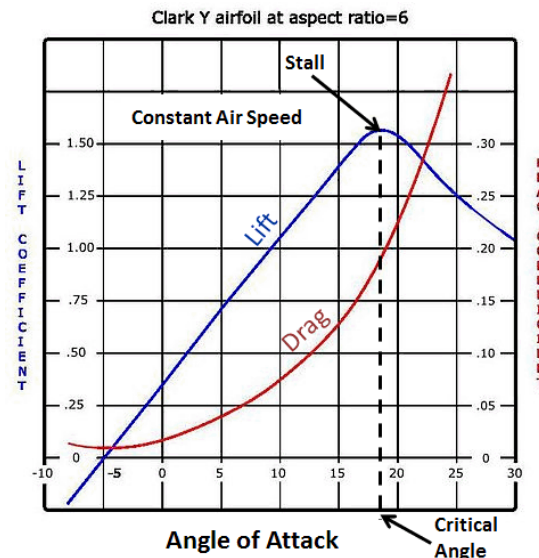
$$L = \frac{1}{2} \rho V_r^2 A_{bl} C_L \left(\alpha, \frac{l}{c}, R_e \right)$$

$$D = \frac{1}{2} \rho V_r^2 A_{bl} C_D \left(\alpha, \frac{l}{c}, R_e \right)$$

$$A_{bl} = cl,$$

where c is the cord

and l is the thickness



https://www.mpoweruk.com/flight_theory.htm

The pitch is the angle between the blade velocity (direction of motion) and chord, it is determined by the blade design.
 The angle of attack, α , is between the relative wind velocity and the chord determines C_L and C_D .
 The angle of attack changes as the wind speed changes.
 The complement of $\alpha + \theta$ is β .
 $\beta = (90 - (\alpha + \theta))$ determines the forces on the wing and power.

$$\mathcal{P}_{bl} = (\text{torque} \times \omega) = F_V \times (\omega R) = F_V V$$

F_V is the force in the direction of motion of the blade

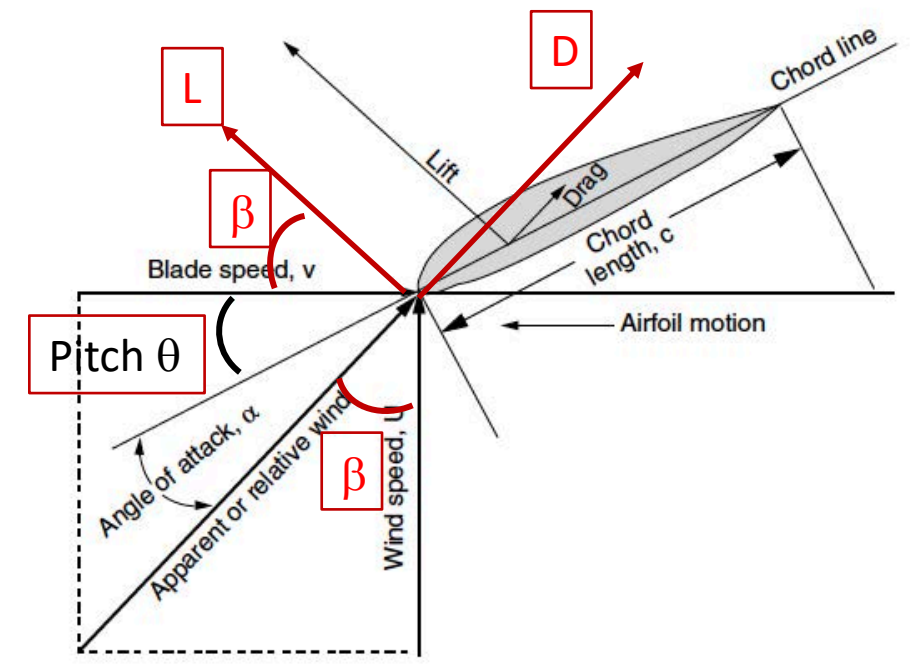
$$F_V = L \cos \beta - D \sin \beta,$$

where $\cos \beta = \frac{U}{V_r}$, and $\sin \beta = \frac{V}{V_r}$ ($\beta = \tan^{-1} \frac{V}{U}$)

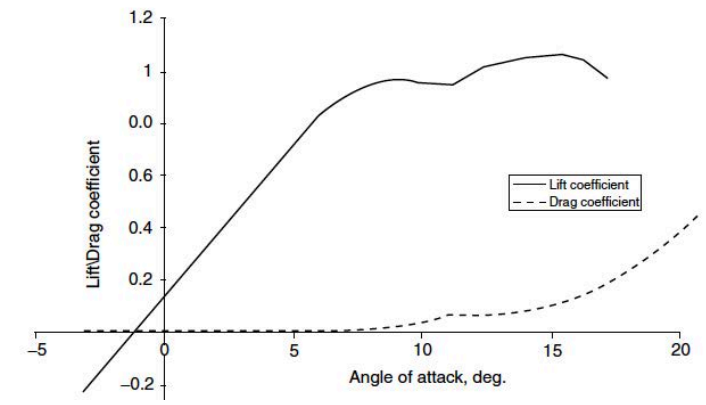
$$F_V = \left(L \frac{U}{V_r} - D \frac{V}{V_r} \right) = \frac{1}{2} \rho V_r U \left(C_L - \frac{V}{U} C_D \right) A_{bl}$$

$$\mathcal{P}_{bl} = F_V V = \frac{1}{2} \rho U^3 A_{bl} \left(C_L - \frac{V}{U} C_D \right) \frac{V}{U} \sqrt{1 + \left(\frac{V}{U} \right)^2} = \frac{1}{2} \rho U^3 A_{bl} C_p$$

Note that the angle of attack (and C_L , C_D) changes with $\left(\frac{V}{U} \right)$



Schematic of translating lift device.



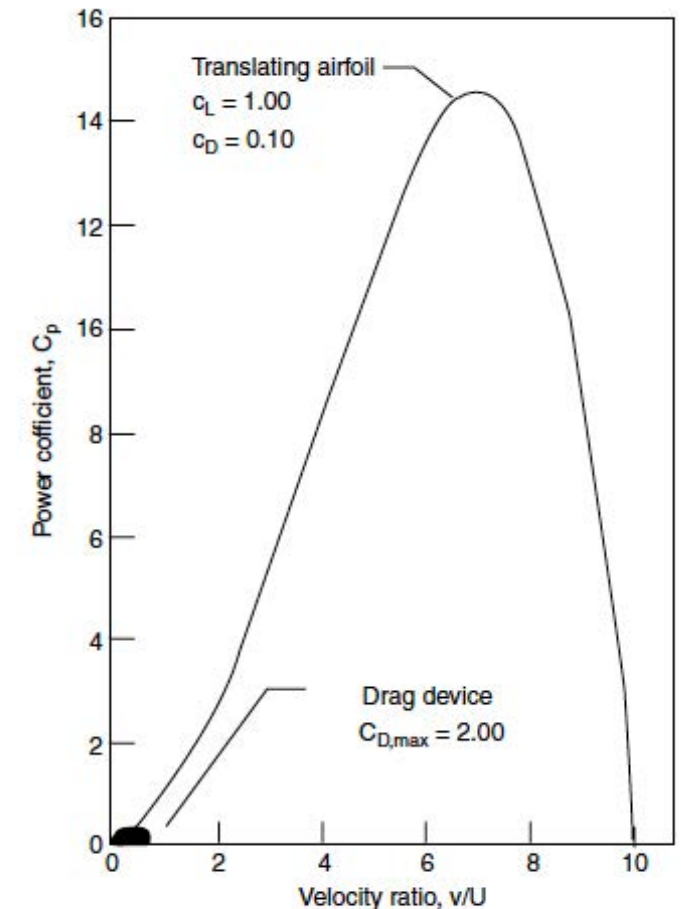
Goswami and Kreith, Energy Conversion, CRC Press, 2008. 18

$$(C_p)_{bl} = \frac{F_V V}{\frac{1}{2} \rho U^3 A_{bl}} = \left(C_L - \frac{V}{U} C_D \right) \frac{V}{U} \sqrt{1 + \left(\frac{V}{U} \right)^2}$$

Modern *wind turbine* operate on the principle of lifting surfaces with high C_p , $O(10)$.
 (Old *wind mills* operated on the drag force created by a wake and are much less efficient, with $C_p < 1.0$)).

- (V/U) is known as the tip speed ratio (evaluated at the tip of the blade).
- Good wind speed is 5-8 m/s.
- For large turbines, R is 10-100 m, and RPM is 10-30 (with smaller turbines spinning faster). V is 50-100 m/s.
- Should choose blades with high C_L (of the order of 1.0) and low C_D (of the order of 0.1).
- Higher values of V/U raise C_p . *But very high values reduce C_p (see equation and plot)*

Power coefficients for drag-type (old fashion) and lift-type (new designs) machines.



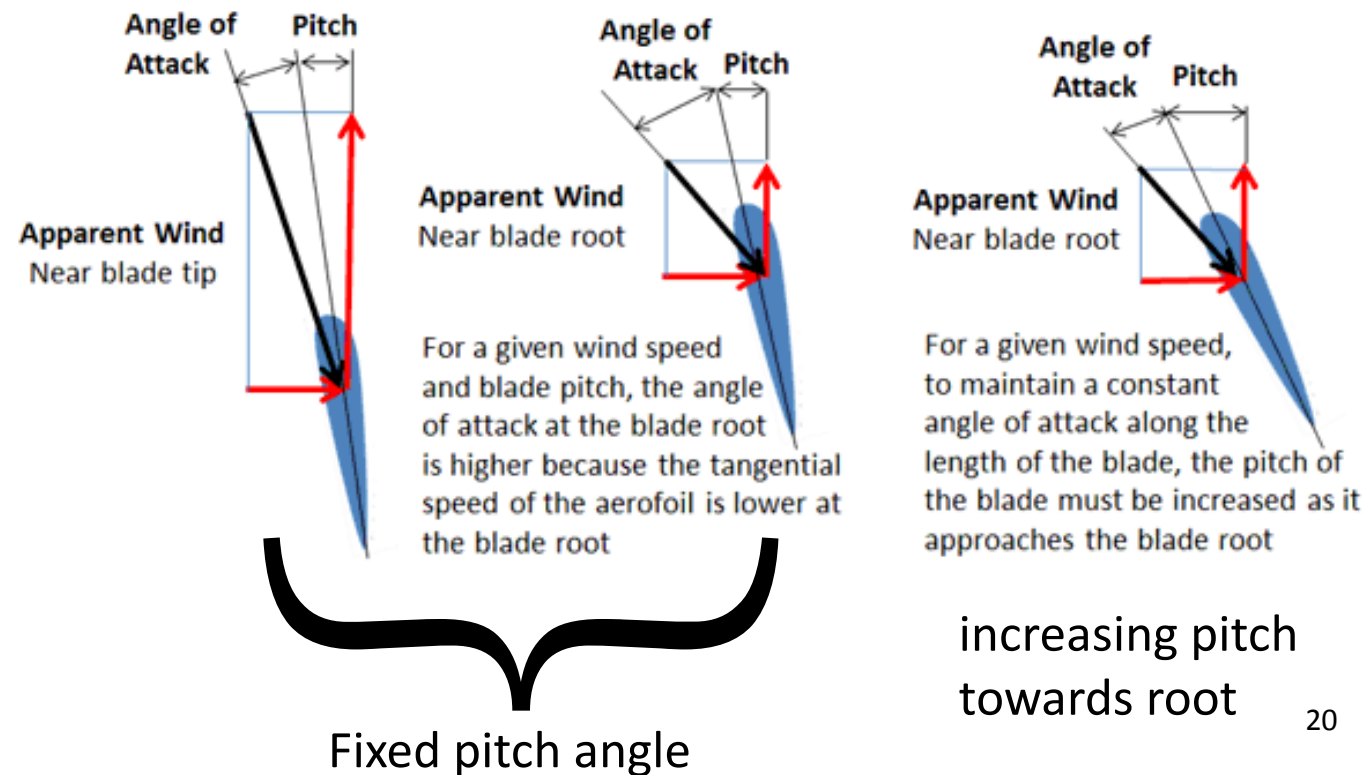
Goswami and Kreith, Energy Conversion, CRC Press, 2008.

- Previous analysis is applicable at some radius along the blade.
- But blade speed increases along r ($V = \omega r$) while U remains constant, causing V/U or α , θ and β to change.
- For a good design, the blade pitch θ must change with radius to maintain optimal $(\alpha + \theta)$ or β almost constant, i.e., must use twisted blades between the root and tip.
- For optimal performance, it is also necessary to vary the overall blade angle as the wind speed changes to maximize C_p , this is *Pitch Control*.
- Speed sensors are mounted on the nacelle to measure the wind speed and adjust the blade pitch.
- It is important that the horizontal turbine axis is always aligned in the wind direction; this is *Yaw Control*.



© The Institution of Engineering and Technology. All rights reserved. This content is excluded from our Creative Commons license. For more information, see <https://ocw.mit.edu/fairuse>.

Angle of Attack and Blade Twist



Almost all modern wind turbine have 3 blades, optimized to operate at highest efficiency at nominal wind speeds

- It is important to keep $(V/U)_{\max \text{ power}}$ low to minimize stresses on blades, etc. (at $U \sim 10 \text{ m/s}$, $V \sim 100 \text{ m/s}$!)
- “Old fashion” wind mills operate more on the principle of *wake drag* in which the blades are almost perpendicular to the wind.
 - This is less efficient and requires wider blades, and more of them.
 - They also spin slower and generate higher torques; more suitable for mechanical applications.

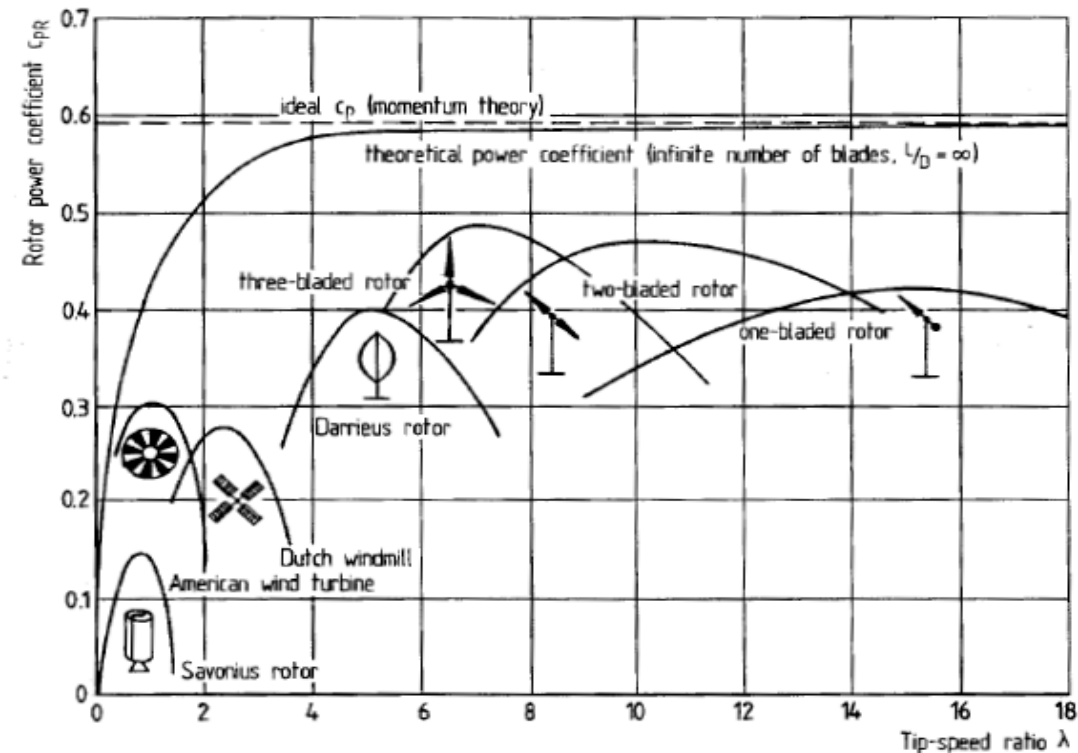


Fig. 5.10. Power coefficients of various of wind rotors [2]

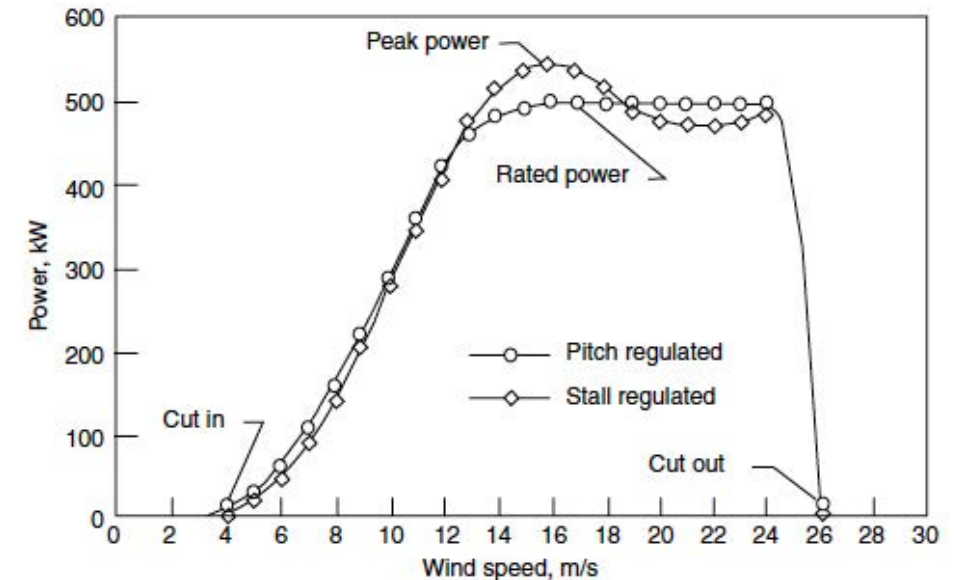
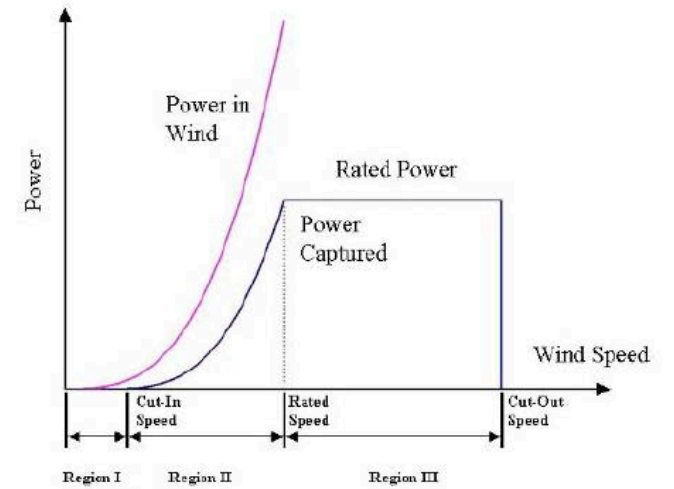
From Wind Turbines by Eric Hau

Wind turbine power-wind speed curve

$$P_{turbine} = \frac{1}{2} C_p \rho U^3 \left(\frac{n_{bl} A_{bl}}{A} \right) A = \frac{1}{2} C_{p,tur} \rho U^3 A, \quad \text{where } A \text{ is the disc area}$$

$$C_{p,Betz} = 0.593, \quad C_{p,tur} = 0.4 - 0.5$$

- Most modern wind turbines operate over a range of wind speed, hence power (depending on the generator, the RPM can be fixed or can vary).
- Must limit the forces on the turbine, and hence the tip speed, to protect the structural integrity, there is a maximum allowable tip speed.
- At this tip speed, the power is nearly constant, determined mostly by the pitch angle of the blade (can force the blade to stall to stop extracting more power) until stall.



Power curve for pitch-regulated and stall regulated wind turbine

$$P_{turbine} = \frac{1}{2} C_p \rho U^3 A, \quad C_p = 0.4 - 0.5$$

- For tall turbines, wind speed changes with height outside the atmospheric boundary layer, but the pattern is seasonal.
- Most of the time, the impact of the change on the power is not as significant because of the change in density.
- For large turbines, the height of the tower is determined more by the size of the blades.

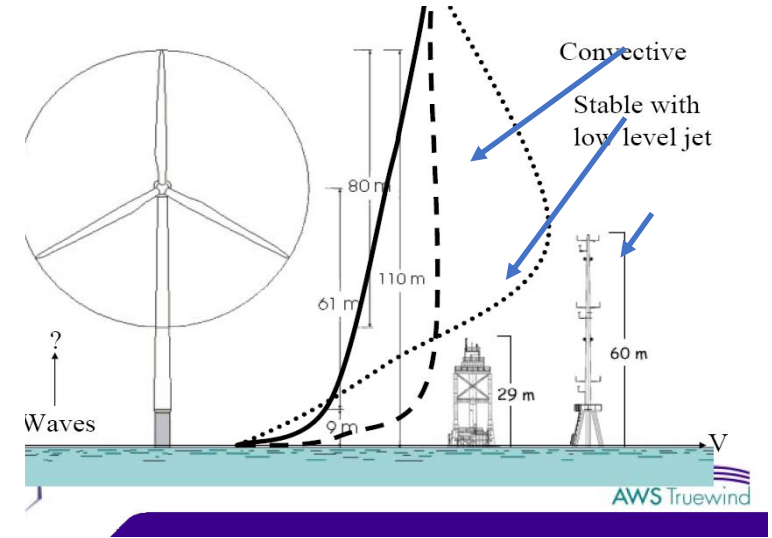
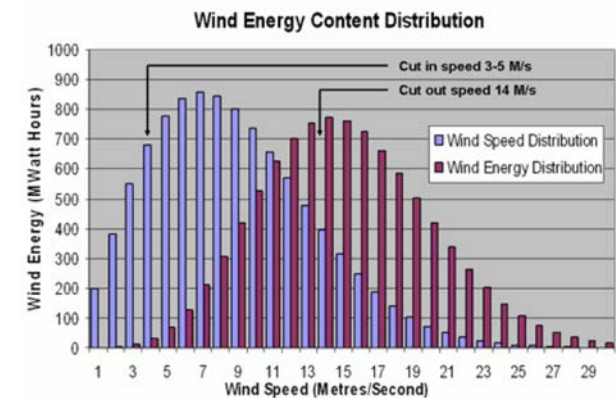
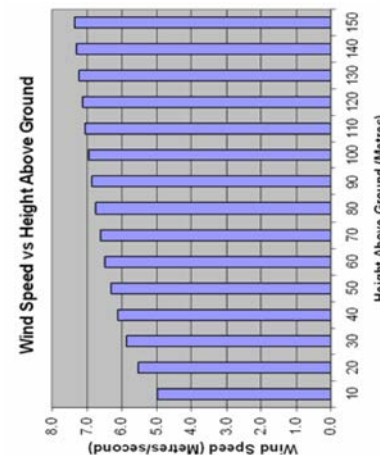


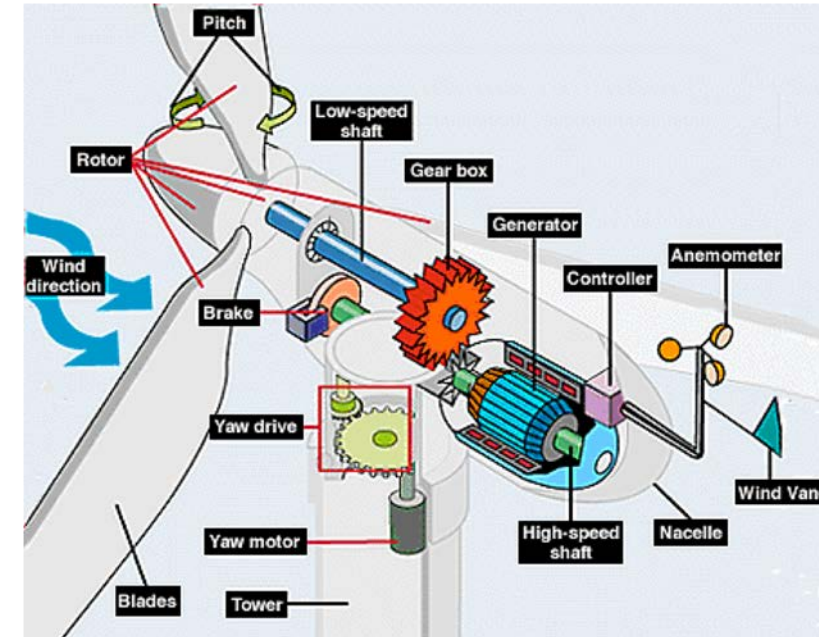
Image courtesy of AWS Truewind, NREL, DOE.



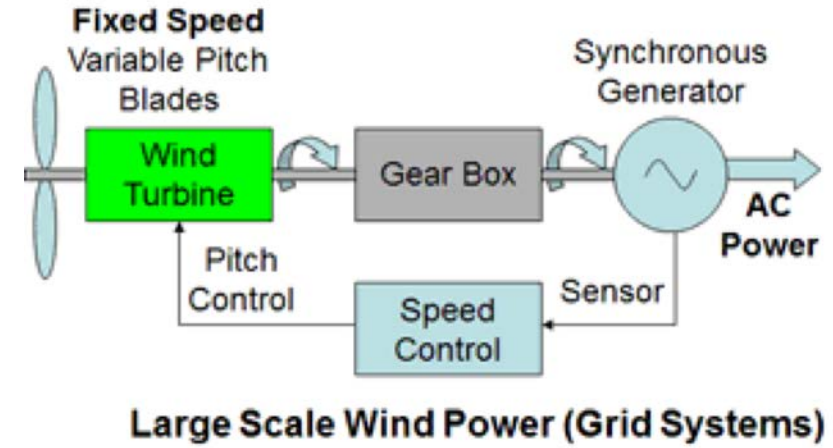
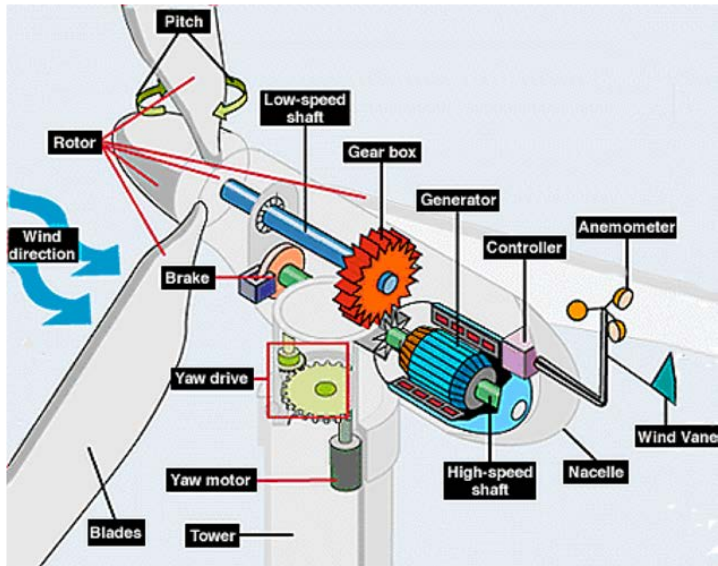
The blue shows the pdf of wind speed, while the red is the power at different wind speeds.

Generators

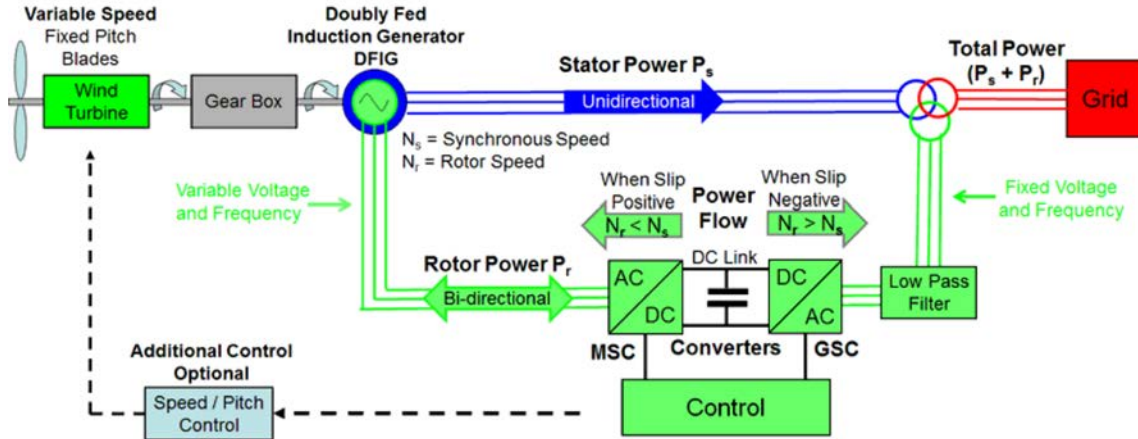
- Most turbines (especially the larger ones) utilize induction (asynchronous) generators. These generators have simple rugged construction, and can be used as motors (reversing the current) for starting up the turbine.
- Power electronics are used to condition the power (frequency and voltage instabilities) before sending it to the grid.
- The generators can operate with variable speed (in case the rotational speed of the turbine varies in response to changing the wind conditions, again using power electronics to condition the power (especially the frequency of the AC current) before feeding to to the grid.
- Synchronous generators are also used, which can be directly connected with the turbine shaft.



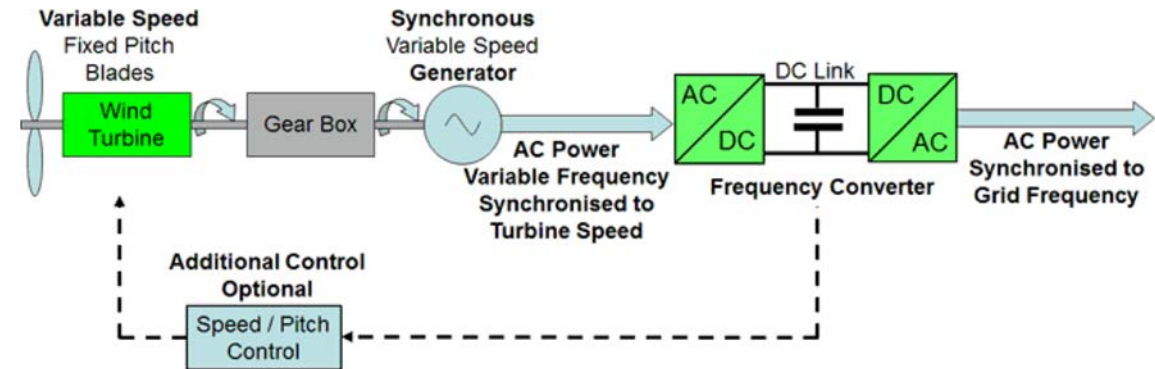
What is inside the nacelle?



Asynchronous DFIG Wind Power Generator (Grid Scale)



Large Scale Wind Power with In-Line Frequency Conversion (Grid Systems)



Double fed Induction Generator (DFIG).
 Most widely used because of efficiency, simplicity and price.
 Can be used as a motor to start the turbine.
 Produces high quality power.

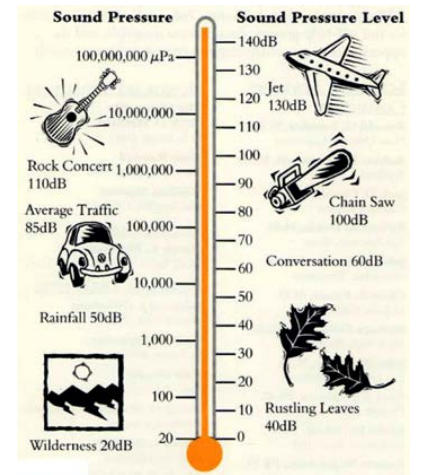
NOISE: Mostly aerodynamic noise are associated with flow over turbine blades:

Jianu et al, World Sustainable Forum, 2011

Sound pressure level is defined as:

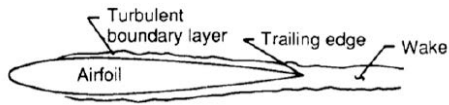
$$SPL = 10 \log_{10} \left(p_{rms}^2 / p_{ref}^2 \right)$$

$$p_{ref} = 10 \mu Pa$$

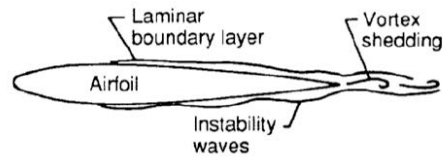


© Source unknown. All rights reserved. This content is excluded from our Creative Commons license. For more information, see <https://ocw.mit.edu/fairuse>.

Turbulent boundary layer trailing edge noise [6].



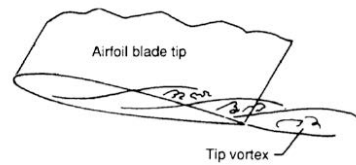
Laminar-boundary-layer vortex shedding noise [6].



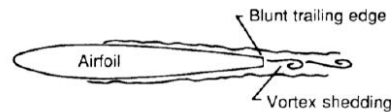
Separation-stall noise [6].



Tip vortex formation noise [6].



Trailing-edge-bluntness vortex-shedding noise [6].



Laminar-Boundary-Layer Vortex-Shedding (LBL VS) Noise

Noise scales with M^5

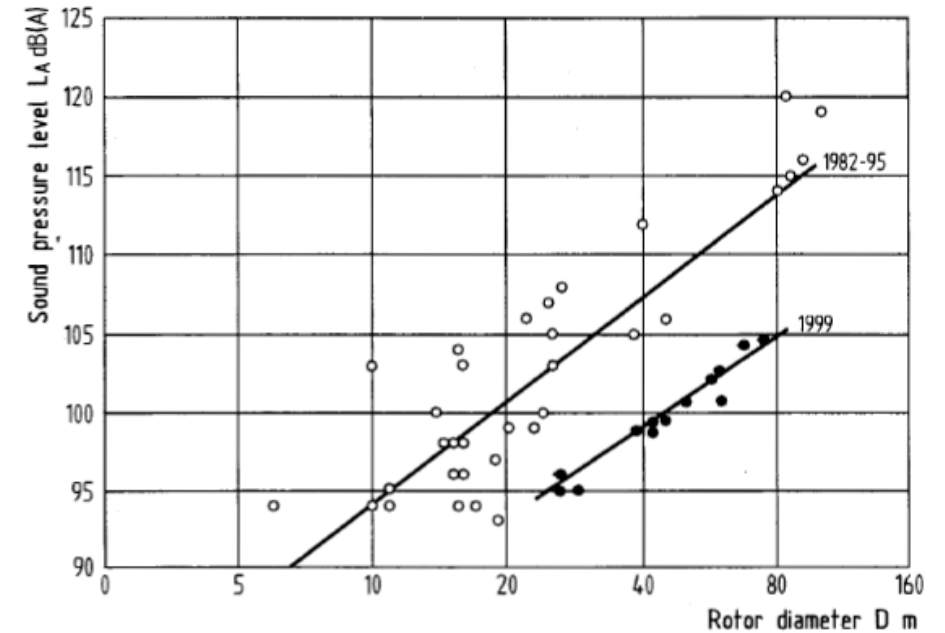
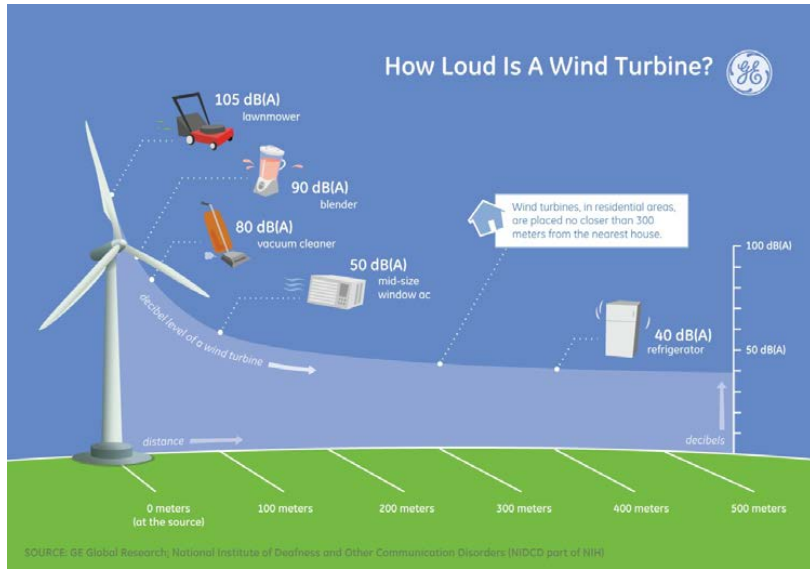


Fig. 17.4. Sound power level of wind turbines [12]

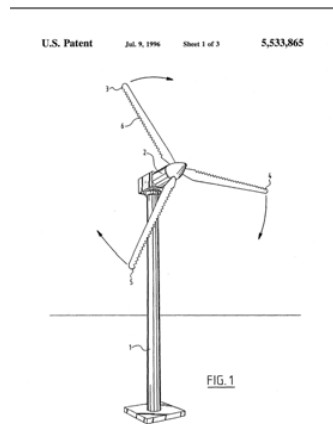
From Wind Turbines by Eric Hau

The noise factor

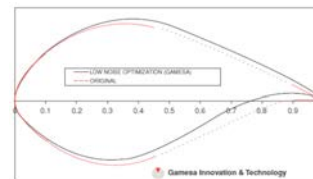


© GE. All rights reserved. This content is excluded from our Creative Commons license. For more information, see <https://ocw.mit.edu/fairuse>.

Emitted mostly from the tip (highest speed)

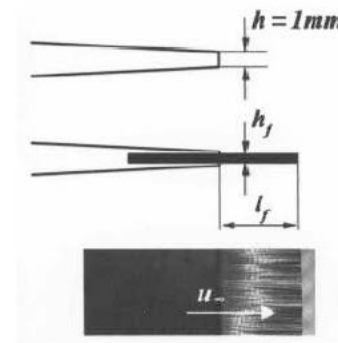


Adding serration to reduce noise



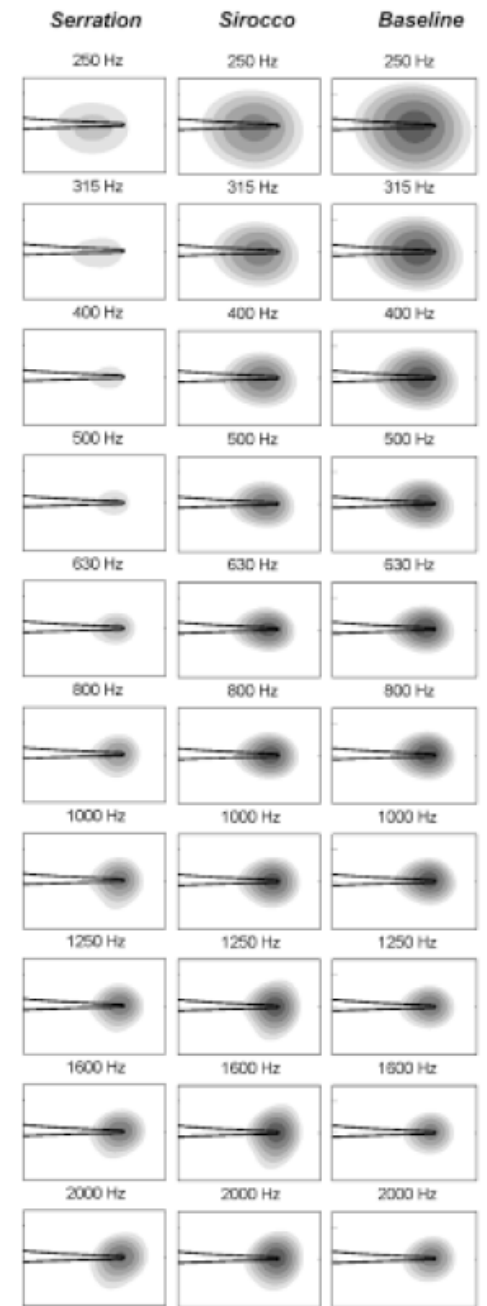
As always with noise, effectiveness depends on frequency

Using brushes can reduce noise by up to 10 dB



Silent rotor by acoustic optimization (SIROCCO)

Jianu et al, World Sustainable Forum, 2011



Wind Farms and minimizing interference

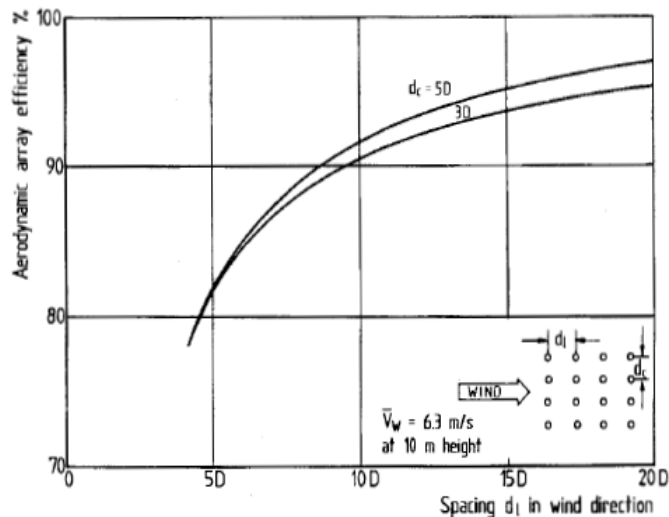


Fig. 16.23. Aerodynamic array efficiency depending on the rotor spacing in wind direction, calculated for a field of 16 wind turbines [21]

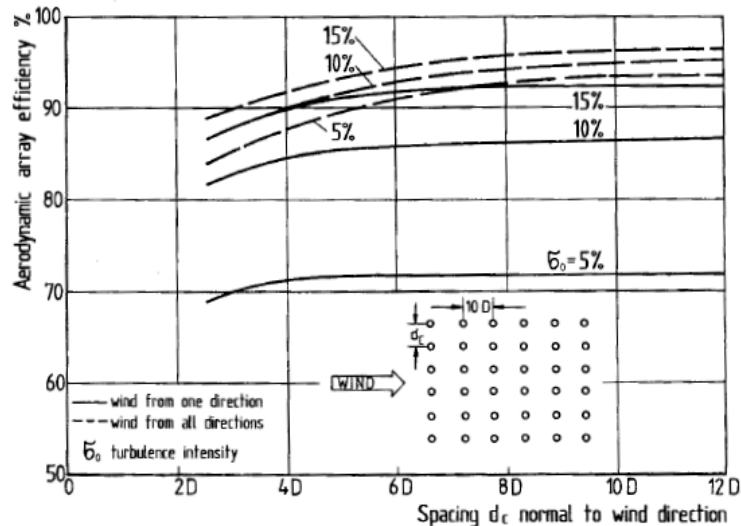


Fig 16.24. Array efficiency depending on the rotor spacing at an angle to the wind and on the turbulence intensity [21]

From Wind Turbines by Eric Hau

© Springer Nature Switzerland AG. All rights reserved. This content is excluded from our Creative Commons license. For more information, see <https://ocw.mit.edu/fairuse>.

- Wakes decay while spreading at a certain angle.
- According to NREL, land required for a single turbine tower (roads, and support structures) is ~ 0.1-0.2 hectares (0.25-0.50 acres).

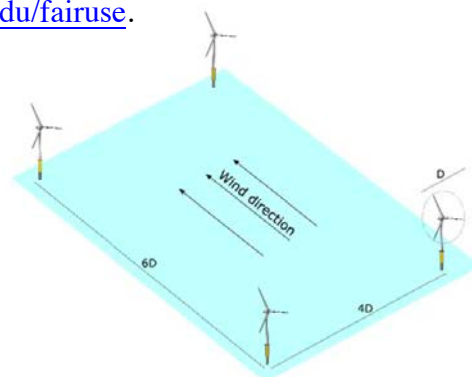


Image courtesy of US Air Force.



FIGURE 12.18 Wake turbulence. Photo credit: Vattenfall Wind Power, Denmark.

© Vattenfall Wind Power, Denmark. All rights reserved. This content is excluded from our Creative Commons license. For more information, see <https://ocw.mit.edu/fairuse>.

© The Associated Press. All rights reserved. This content is excluded from our Creative Commons license. For more information, see <https://ocw.mit.edu/fairuse>.

Off-shore wind

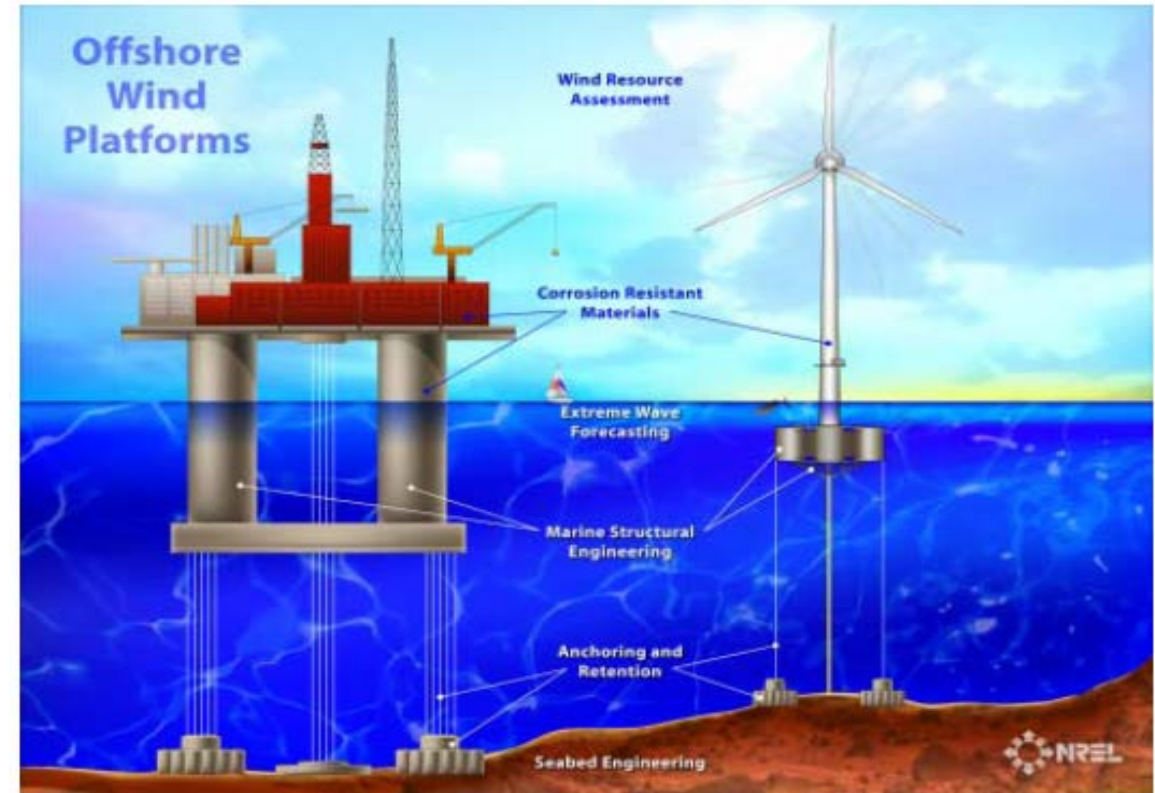
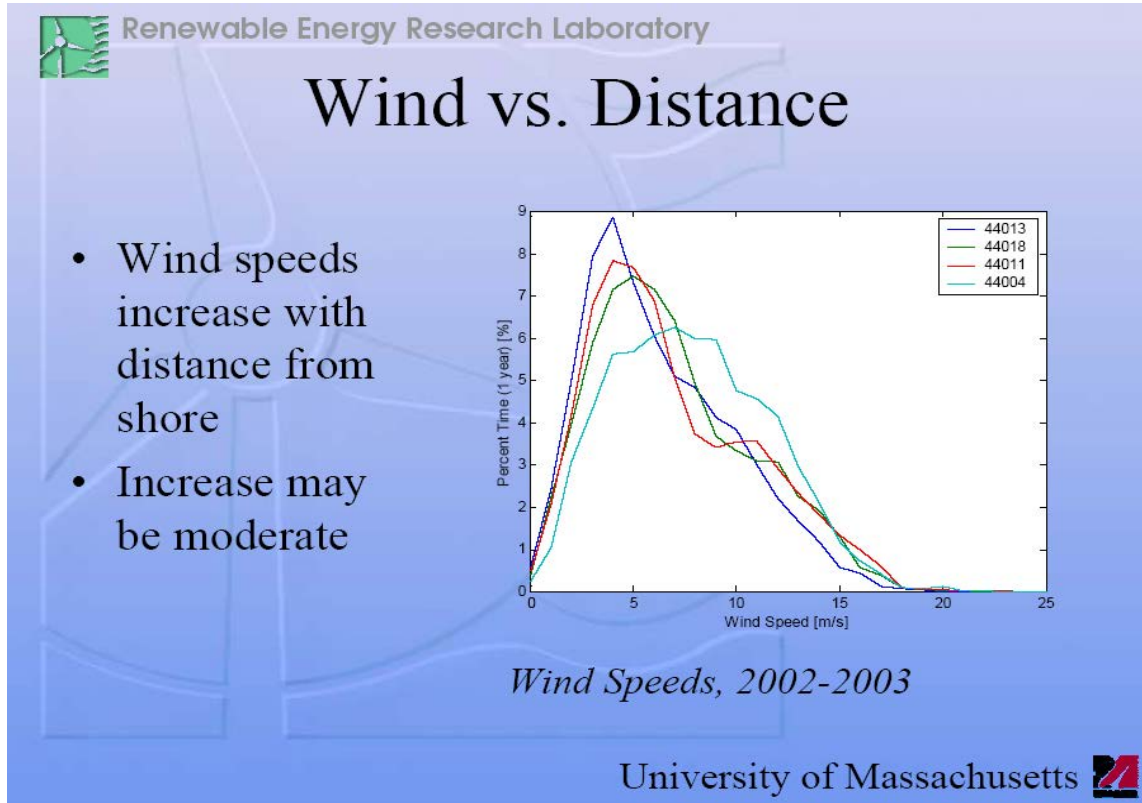


Image courtesy of NREL, DOE.

By 2009, 5-7 MW, by 2015, 10 MW, off shore turbine.
 90-100 m high (hub) and 140 m diameter (rotor).

Mostly floating in 50 m deep water.

Actively controlled blade pitch for variable wind speed.

Different sensors and actuators to protect against wind gust and storms, etc.

Offshore GE Wind Energy 3.6 MW Prototype

•Offshore GE 3.6 MW
 104 meter rotor diameter

•Offshore design requirements
 considered from the outset:

- Crane system for all components
- Simplified installation
- Helicopter platform

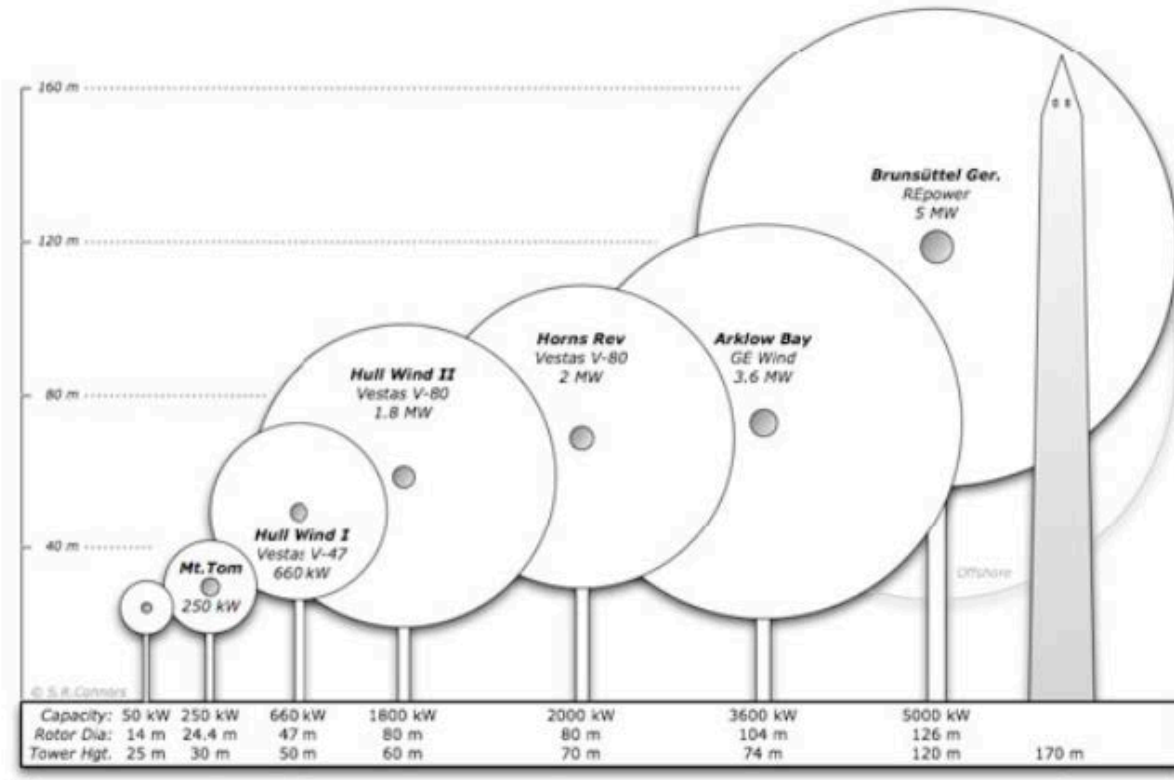


Image courtesy of NREL, DOE.



Horns Rev Wind Farm (Denmark) - Rated Power 160 MW – Water Depth 10-15m

Image courtesy of Bureau of Ocean Energy Management, U.S. Department of the Interior.

Installation must be low cost and weather tollerant.



Vesta 7MW turbines, rotor D = 164 m

https://www.mpoweruk.com/wind_power.htm

© The Institution of Engineering and Technology. All rights reserved.
This content is excluded from our Creative Commons license. For more information, see <https://ocw.mit.edu/fairuse>.



Image courtesy of NREL, DOE.

MIT OpenCourseWare
<https://ocw.mit.edu/>

2.60J Fundamentals of Advanced Energy Conversion
Spring 2020

For information about citing these materials or our Terms of Use, visit: <https://ocw.mit.edu/terms>.